



# BERNINA 500

User manual





# Table of Contents

<b>IMPORTANT SAFETY INSTRUCTIONS</b> .....	<b>7</b>	2.2 Connection and Switching on .....	29
<b>Important information</b> .....	<b>9</b>	Connecting the foot control (Optional accessory) .....	29
<b>1 My BERNINA</b> .....	<b>11</b>	Connecting the machine .....	29
1.1 Introduction .....	11	Fixing the touchscreen pen .....	29
1.2 Welcome to the world of BERNINA .....	11	Switching the machine on .....	30
1.3 Overview Machine .....	13	Switching on the sewing light .....	30
Overview front controls .....	13	2.3 Foot control (Optional accessory) .....	30
Overview front .....	14	Regulating the speed via the foot control .....	30
Overview sideways .....	15	Raising/Lowering the needle .....	31
Overview back .....	16	2.4 Spool pin .....	31
Overview Embroidery module .....	17	Retractable spool pin .....	31
1.4 Supplied accessories .....	17	Horizontal spool pin .....	32
Overview accessories machine .....	17	2.5 Free arm .....	32
Use of the power cable (only USA/Canada) .....	18	2.6 Embroidery foot .....	33
Foot control (only USA/Canada) (Optional accessory) ..	18	Attaching the embroidery foot .....	33
Accessory box .....	19	Selecting the embroidery foot in the User Interface .....	33
Overview accessory Embroidery module .....	19	2.7 Needle and stitch plate .....	34
1.5 Overview User Interface .....	20	Inserting the embroidery needle .....	34
Overview functions/visual information .....	20	Selecting the embroidery needle in the User Interface ...	35
Overview System settings .....	21	Selecting the needle type and the needle size .....	35
Overview Selection menu embroidery .....	21	Adjusting the needle position up/down .....	35
Overview Icons .....	21	Attaching the stitch plate .....	36
1.6 Needle, Thread, Fabric .....	22	Selecting the stitch plate in the User Interface .....	36
Overview Needles .....	23	2.8 Threading .....	37
Example for needle description .....	23	Threading the upper thread .....	37
Needle/thread combination .....	24	Winding the bobbin thread .....	39
Upper thread .....	24	Threading the bobbin thread .....	40
Bobbin thread .....	25	Thread-up command .....	42
1.7 Important Embroidery information .....	25	Indicating fill level of bobbin thread .....	42
Selecting the embroidery file format .....	25	2.9 Attaching the Module .....	43
Embroidery test .....	25	2.10 Removing the embroidery module .....	43
The size of the embroidery motif .....	25	2.11 Selecting the embroidery motif .....	43
Embroidering motifs by third-party providers .....	25	2.12 Embroidery hoop .....	44
Underlay stitches .....	26	Overview Embroidery hoop selection .....	44
Satin or Leaf stich .....	26	Selecting the embroidery hoop .....	44
Step stitch .....	26	Tear-away stabilizers .....	44
Connecting stitches .....	27	Cut-away stabilizers .....	45
<b>2 Embroidery preparation</b> .....	<b>28</b>	Using adhesive spray .....	45
2.1 Accessory box .....	28	Using spray starch .....	45
Removing and attaching the accessory box .....	28	Using iron-on interfacing .....	45
Storing accessories .....	28	Using paper-backed adhesive stabilizer .....	45
		Using water-soluble stabilizer .....	45
		Preparing the embroidery hoop .....	46



Attaching the hoop .....	47	4.5	Cancelling any alterations with «clr» .....	66
Overview embroidery functions .....	47	<b>5</b>	<b>Creative embroidering .....</b>	<b>67</b>
Center the needle to the embroidery hoop .....	47	5.1	Overview embroidering .....	67
Moving the hoop to the back .....	48	5.2	Selecting and changing the embroidery motif .....	67
Moving the embroidery arm to the left .....	48	5.3	Checking the embroidery time and the embroidery motif size .....	67
Grid on/off .....	48	5.4	Regulating the speed .....	67
Locating the center of the embroidery motif .....	48	5.5	Editing the embroidery motif .....	68
Virtual positioning of the embroidery hoop .....	49		Overview Editing embroidery motif .....	68
<b>3</b>	<b>Setup Program .....</b>		Scaling up the embroidery motif view .....	68
			Downsizing the embroidery motif view .....	68
3.1	Embroidery settings .....		Moving the embroidery motif view .....	69
	Adjusting the upper thread tension .....		Moving the embroidery motif in enlarged view .....	69
	Adjusting the maximum embroidering speed .....		Moving the embroidery motif .....	69
	Setting the embroidery motif position when opening ..		Rotating motif .....	70
	Calibrating the hoop .....		Altering the embroidery motif size proportionally .....	70
	Entering the fabric thickness .....		Altering the embroidery motif size disproportionately .....	71
	Function thread away on/off .....		Mirroring embroidery motifs .....	71
	Programming securing stitches (Smart Secure) .....		Bending the text .....	71
	Adjusting the thread cut .....		Changing the stitch type .....	72
	Changing the measuring unit .....		Altering the stitch density .....	72
3.2	Selecting personal settings .....		Checking the embroidery motif size and position .....	73
3.3	Monitoring functions .....		Endless embroidery .....	74
	Activating the upper thread indicator .....		Duplicating the embroidery motif .....	75
	Activating the bobbin thread indicator .....		Deleting an embroidery motif .....	76
3.4	Activating the audio signals .....		Changing the sequence within an embroidery motif combination .....	76
3.5	Machine settings .....		Undoing entries .....	76
	Selecting a language .....		Grouping embroidery motifs .....	77
	Adjusting the brightness of the display .....	5.6	Pinpoint placement .....	78
	Adjusting the sewing light .....		Positioning of grid points .....	78
	Checking the firmware version .....		Free point positioning .....	79
	Reviewing the total number of stitches .....	5.7	Combining embroidery motifs .....	80
	Registering details of the dealer .....		Combining embroidery motifs .....	80
	Saving Service data .....		Deleting a single embroidery motif .....	80
	Back to basic setting .....		Duplicating a combination .....	81
	Deleting user data .....	5.8	Creating lettering .....	82
	Deleting motifs on the BERNINA USB Stick .....		Overview embroidery alphabets .....	82
	Updating the machine Firmware .....		Creating words/sentences .....	82
	Recovering saved data .....		Editing words/sentences .....	83
	Cleaning the thread catcher .....	5.9	Changing the colors of the embroidery motif .....	84
	Lubricating the machine .....		Overview changing the color .....	84
	Packing the embroidery module .....		Changing the colors .....	84
			Altering the colors via the color wheel .....	85
<b>4</b>	<b>System settings .....</b>		Changing the thread brand .....	86
4.1	Calling up the Tutorial .....			
4.2	Calling up the embroidery consultant .....			
4.3	Using eco mode .....			
4.4	Calling up the Help .....			



5.10	Embroidering the embroidery motif .....	86	<b>8</b>	<b>Overview stitch patterns .....</b>	<b>106</b>
	Overview Embroidery menu .....	86	8.1	Overview Embroidery motifs .....	106
	Adding basting stitches .....	86		Editing embroidery motifs .....	106
	Moving the hoop .....	87		Projects .....	106
	Embroidery sequence control when thread breaks .....	87		Quilt motifs .....	107
	Cutting connecting stitches .....	87		Ornaments .....	116
	Reducing color changes .....	87		Children .....	123
	Multi-colored embroidery motif on/off .....	88		Frames and borders .....	129
	Endless Embroidery .....	88		Seasons .....	131
	Color indication .....	89		Borders and Lace .....	137
5.11	Free arm embroidering .....	89		Sports and hobby .....	142
5.12	Administering embroidery motifs .....	90		Animals .....	146
	Administering embroidery motifs .....	90		Flowers .....	147
	Saving embroidery motifs in the personal memory .....	90		Designs with special effects .....	152
	Saving the embroidery motif on the BERNINA USB stick .....	91			
	Overwriting the embroidery motif in the personal memory .....	91		<b>Index .....</b>	<b>157</b>
	Overwriting the embroidery motif on the BERNINA USB stick .....	91			
	Loading an embroidery motif from the personal memory .....	92			
	Loading an embroidery motif from the BERNINA USB stick .....	92			
	Deleting an embroidery motif from the personal memory .....	92			
	Deleting an embroidery motif from the BERNINA USB stick .....	92			
<b>6</b>	<b>Embroidery .....</b>	<b>93</b>			
6.1	Embroidering via the button «Start/Stop» .....	93			
6.2	Increasing the embroidery speed .....	93			
6.3	Adjusting the upper thread tension .....	93			
6.4	Embroidering via the foot control (Optional accessory) .....	94			
<b>7</b>	<b>Appendix .....</b>	<b>95</b>			
7.1	Maintenacnce and cleaning .....	95			
	Cleaning the display .....	95			
	Removing thread remnants under the stitch plate .....	95			
	Cleaning the hook .....	95			
	Lubricating the hook .....	96			
7.2	Troubleshooting .....	98			
7.3	Error messages .....	100			
7.4	Storage and disposal .....	104			
	Storing the machine .....	104			
	Dispose of the machine .....	104			
7.5	Technical data .....	105			





- Only use accessory recommended by the manufacturer.
- Don't use this machine when the ventilation openings are blocked. Keep the ventilation openings and the foot control free from the accumulation of lint, dust and loose cloth.
- Never insert any objects into any openings of the machine.
- Do not place any objects on the foot control.
- Always use the machine with a foot control of this type -.
- Do not operate the machine where aerosol products (sprays) or oxygen are being used.
- Keep fingers away from all moving parts. Special care is required around the needle.
- Neither pull nor push the fabric while sewing. This can cause needle breakage.
- When making any adjustments in the needle area – such as such as threading the needle, changing the needle, threading the hook or changing the presser foot – turn power switch to «0».
- Do not use bent needles.
- Always use the original BERNINA stitch plate. The wrong stitch plate can cause needle breakage.
- To disconnect, turn power switch to «0» and then remove the plug from the outlet. Do not unplug by pulling the cord, instead grasp the plug to pull it from the outlet.
- Always disconnect the power plug from the electrical outlet when the covers are removed or opened, when the machine is lubricated or during any other maintenance adjustments mentioned in the instruction manual.
- This machine is provided with double insulation (except USA, Canada and Japan). Use only identical replacement parts. See instructions for Servicing of double-insulated products.
- The sound pressure level is lower than 70 dB(A) under normal conditions.







## Explanation of symbols



Designates a high-risk hazard which can lead to serious injuries or potentially even death if not avoided.



Designates a medium-risk hazard which can lead to serious injuries if not avoided.



Designates a low-risk hazard which can lead to minor or moderate injuries if not avoided.



Designates a hazard which can lead to material damage if not avoided.



**Tips** by BERNINA **Embroidery experts** can be found next to this sign.

# 1 My BERNINA

## 1.1 Introduction

Your BERNINA 500 enables you to be endlessly creative due to the various applications. Delicate silk or satin fabrics as well as heavy-weight linen, fleece and denim can be embroidered successfully with this machine. Numerous embroidery motifs are at your disposal.

Additional to this instruction manual, following help programs are provided which will give you useful advice and support at any time how to operate you BERNINA 500.

The **Tutorial** gives information and explanations concerning various aspects of embroidering.

The **Embroidery Consultant** informs you about decision support for embroidery projects. After entering the desired embroidery project and the fabric, suggestions for the suitable needle and the suitable embroidery foot are displayed.

The **Help Program** contains information about individual embroidery motifs, functions and applications in the User Interface.

### Further information

In addition to this instruction manual of your BERNINA 500 further information products are enclosed.

The latest version of your instruction manual as well as additional information in connection with the machine and accessories can be found on our website <http://www.bernina.com>

## 1.2 Welcome to the world of BERNINA

Made to create, this is the slogan of BERNINA. Not only with our machines do we support you in the implementation of your ideas. In addition to the offers listed below, we offer you lots of suggestions and instructions for your future projects as well as the opportunity to exchange ideas with other sewing, quilting and embroidery enthusiasts. We wish you lots of pleasure.

### BERNINA YouTube Channel

On YouTube we offer a wide range of how-to videos and support concerning the most important functions of our machines. Detailed explanations are also provided as for the various presser feet, so that your projects will succeed completely.

<http://www.youtube.com/BerninaInternational>

Provided in the languages English and German.

### inspiration – the sewing magazine

Are you looking for ideas and instructions for great projects? In that case the BERNINA magazine «inspiration» is exactly what you need. «inspiration» offers extraordinary sewing and embroidery ideas four times a year. From seasonal fashion trends to trendy accessories and practical tips to decorate your home in an original way.

<http://www.bernina.com/inspiration>

The magazine is available in the languages English, German, Dutch and French. Not available in all countries.

### **BERNINA Blog**

Fancy instructions, free sewing patterns and embroidery motifs as well as many new ideas: all this you can find in the weekly blog by BERNINA. Our experts give valuable tips and explain step by step how you can achieve the desired result. In the community you can upload your own projects and exchange experiences and ideas with other sewing and embroidering enthusiasts.

<http://www.bernina.com/blog>

Provided in the languages English, German and Dutch.

### **BERNINA Social Media**

Follow on social networks to learn more about events, thrilling projects as well as tips and tricks all about sewing, quilting and embroidering. We will keep you informed and we are looking forward to presenting you the one or the other highlight from the world of BERNINA.

<http://www.bernina.com/social-media>



## 1.3 Overview Machine

### Overview front controls



- |   |                         |   |                            |
|---|-------------------------|---|----------------------------|
| 1 | Sewing light on/off     | 6 | Upper multifunction knob   |
| 2 | Thread cutter           | 7 | Lower multifunction knob   |
| 3 | Start/Stop              | 8 | Center of embroidery motif |
| 4 | Checking the motif size | 9 | Pinpoint placement         |
| 5 | Needle up/down          |   |                            |

## Overview front



- |   |                                  |    |                               |
|---|----------------------------------|----|-------------------------------|
| 1 | Connection for embroidery module | 8  | Slide speed control           |
| 2 | Bobbin cover                     | 9  | Thread take-up lever cover    |
| 3 | Connection for accessories       | 10 | Thread take-up lever          |
| 4 | Embroidery foot                  | 11 | Thread cutter                 |
| 5 | Needle threader                  | 12 | Fixing screw                  |
| 6 | Sewing light                     | 13 | Connection for slide-on table |
| 7 | Thread cutter                    |    |                               |



### Overview back



- |   |                               |    |                     |
|---|-------------------------------|----|---------------------|
| 1 | Air vents                     | 7  | Bobbin winding unit |
| 2 | Connection for slide-on table | 8  | Thread pretension   |
| 3 | Carrying handle               | 9  | Thread guide        |
| 4 | Spool pin                     | 10 | Presser foot lifter |
| 5 | Thread guide                  | 11 | Thread cutter       |
| 6 | Retractable spool pin         | 12 | Stitch plate        |



## Overview Embroidery module



- |   |                                |   |                             |
|---|--------------------------------|---|-----------------------------|
| 1 | Release lever/carrying handle  | 4 | Guide rails for the machine |
| 2 | Embroidery arm                 | 5 | Connection to the machine   |
| 3 | Coupling for securing the hoop |   |                             |

## 1.4 Supplied accessories

### Overview accessories machine











Illustration	Name	Purpose
	Dust cover	To protect the machine from dust and contamination.
	Accessories box	To store the supplied accessories as well as the optional accessories.

Illustration	Name	Purpose
	Spool disc 3 different sizes for thread spools in different sizes.	To support the regular unwinding of the thread from the spool.
	Bobbin 4 pieces, 1 of them in the machine	To wind the bobbin thread.
	Foam pad 2 pieces	To prevent the thread from slipping under the spool holder, tangling and breaking.
	Touchscreen pen	For precise operation of the touch display.
	Seam ripper	To undo seams and to cut buttonholes open.
	Screwdriver red (slot)	To loosen and tighten slotted screws.
	Brush	To clean the feed dog and the looper area.
	Sewing machine oil	To oil the machine.
	Power cable	To connect the machine with the power supply system.

### Use of the power cable (only USA/Canada)

The machine has a polarized plug (one contact is wider than the other). To reduce the risk of electric shock, the plug can only be plugged into the socket in one way. If the plug does not fit into the socket, turn the plug. If it still does not fit, contact an electrician to install an appropriate outlet. Do not modify the plug in any way.

### Foot control (only USA/Canada) (Optional accessory)

Use only foot controller type LV-1 with BERNINA 500.

## Accessory box



- |   |                                    |   |                      |
|---|------------------------------------|---|----------------------|
| 1 | Drawer                             | 5 | Spool pin            |
| 2 | Embroidery foot                    | 6 | Foam pad             |
| 3 | Holder for embroidery feet, 5,5 mm | 7 | Selection of needles |
| 4 | Holder for embroidery feet, 9,0 mm |   |                      |

## Overview accessory Embroidery module







Illustration	Name	Purpose
	Embroidery foot #26	For embroidering, darning and free-motion quilting.
	Large oval embroidery hoop	To embroider large embroidery motifs or motif combinations up to 145 x 255 mm (5.70 x 10.04 in).  Including the template for precise fabric positioning.

Illustration	Name	Purpose
	Medium embroidery hoop	To embroider medium-sized embroidery motifs up to 100 x 130 mm (3.94 x 5.12 in).  Including the template for precise fabric positioning.
	USB Connecting cable	To transfer data from the computer to the machine or vice versa.
	Embroidery needle assortment	For embroidering.
	Template holder	To place and remove the template in or out of the embroidery hoop.
	Net for upper thread spool	To support an even unwinding of the thread with slippery embroidery threads.

## 1.5 Overview User Interface

### Overview functions/visual information

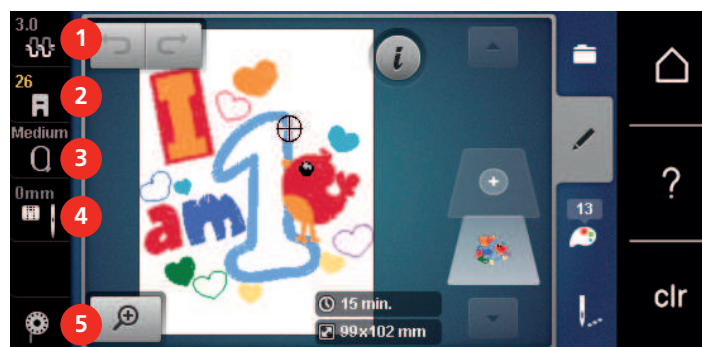

- |   |   |   |                               |
|---|---|---|-------------------------------|
| 1 | Upper thread tension                              | 4 | Stitch plate/Needle selection |
| 2 | Presser foot indicator / presser foot selection   | 5 | Threading the bobbin thread   |
| 3 | Embroidery hoop display/Embroidery hoop selection |   |                               |

## Overview System settings

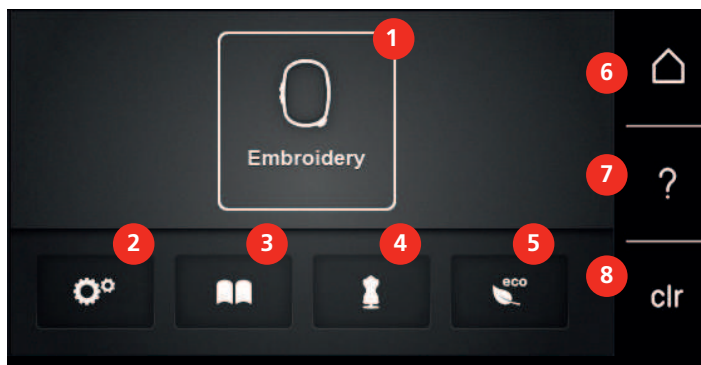



- |   |                       |   |                         |
|---|-----------------------|---|-------------------------|
| 1 | Embroidery mode       | 5 | eco                     |
| 2 | Setup Program         | 6 | Home                    |
| 3 | Tutorial              | 7 | Help                    |
| 4 | Embroidery Consultant | 8 | Back to default setting |

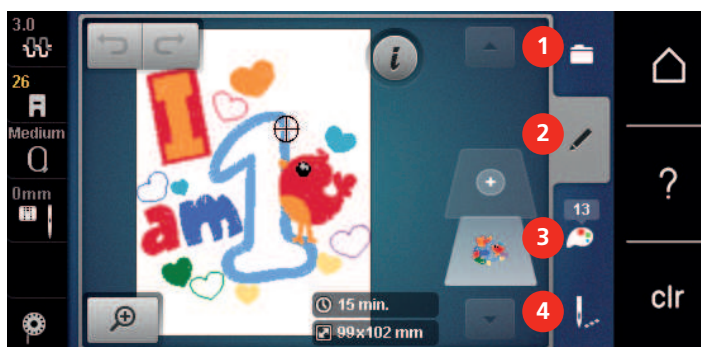







## Overview Selection menu embroidery



- |   |                             |   |                   |
|---|-----------------------------|---|-------------------|
| 1 | Selection embroidery motifs | 3 | Color information |
| 2 | Editing embroidery motifs   | 4 | Embroidery        |

## Overview Icons

Icon	Name	Purpose
	i-Dialog	Under the icon «i» dialog, you can find different functions for editing patterns.
	ESC	The window is closed and the changes that were previously set are implemented.

Icon	Name	Purpose
 	Icons «-/+»	You can use the icons «-» and «+» to change setting values.
	Yellow frame around the icon	A yellow-framed icon indicates that a setting or value has been changed in this function. This can be reset to the default setting by touching the yellow-framed icon.
	Confirm	Confirms the changes that were previously made. The window is closed.
	Cancel	The process is canceled. The window is closed and the changes are not implemented.
	Slider	The slider is used to change setting values.
	Switch	The switch is used to switch functions on or off.
	Process navigation	You can use the process navigation to return to the previous display.

**Please note:** Some displays contain more functions than those displayed. You can display hidden functions by swiping your finger or the touchscreen pen upwards or downwards.

## 1.6 Needle, Thread, Fabric

In the course of time a needle wears out. Therefore it should be replaced regularly. Only a perfect point results in a good stitching result. In general it can be said: the thinner the thread, the finer the needle. The illustrated needles are either standard or optional accessory, depending on the machine.

- Needle sizes 70, 75: for thin fabrics.
- Needle sizes 80, 90: for medium fabrics.
- Needle sizes 100, 110 and 120: for heavy fabrics.

## Overview Needles

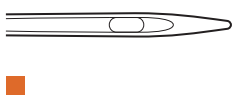
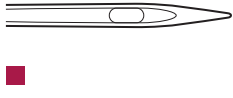
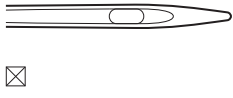
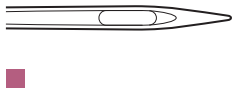
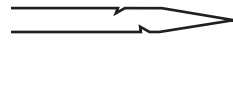
Illustration	Needle name	Needle description	Purpose
	<b>Jersey/Embroidery needle</b> 130/705 H SUK 60-100	Mid-sized ball point	For knitware, knitted good.  For embroidering.
	<b>Embroidery needle</b> 130/705 H-E 75, 90	Small ball point, especially wide needle eye and wide thread groove	For embroidery on all natural and synthetic fabrics.
	<b>Fine-material needle</b> 130/705 H SES 70, 90	Small ball point	For fine knitware and knitted materials.  For embroidery on fine, delicate fabrics.
	<b>Metafil needle</b> 130/705 H METAFIL 80	Long needle eye (2 mm) in all needle sizes	For sewing or embroidering with metallic threads.
	<b>Felt needle</b> PUNCH	Needle with barbed hook	For felt work.

## Example for needle description

The 130/705 system, which is the most common for household machines, is explained by the following picture of a Jersey/Stretch needle.

	<p><b>130/705 H-S/70</b></p> <p><b>130</b> = Shank length (1)</p> <p><b>705</b> = Flat shank (2)</p> <p><b>H</b> = Needle scarf (3)</p> <p><b>S</b> = Needle point (here medium ball point) (4)</p> <p><b>70</b> = Needle size 0.7 mm (5)</p>
---	---

## Needle/thread combination

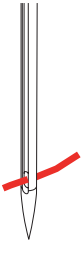
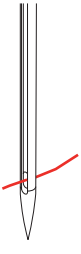
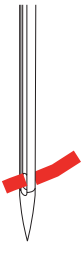
	<p>The needle/thread combination is correct, when the thread fits perfectly into the long groove and goes easily through the needle eye. The thread can be optimally secured.</p>
	<p>The thread can break and skipped stitches can occur when there is too much clearance in the long groove and the needle eye.</p>
	<p>The thread can break and get stuck when the thread scrapes against the edge of the long groove not fit well into the needle eye optimally.</p>

## Upper thread

A good quality thread (brand manufacturer) is essential for embroidery so that the embroidery is not affected negatively because of poor thread or thread breakage.

Embroidery is particularly effective if you use 40wt glossy rayon or polyester embroidery threads as upper threads. They are available in a wide range of colors for beautiful embroidery.

- Glossy polyester with a brilliant sheen is a hard wearing, colorfast thread and has a high tensile strength which is suitable for all types of embroidery.
- Rayon is a soft viscose fiber with a brilliant sheen and suitable for fine, delicate embroidery, or items that will not receive excessive wear and tear.
- Metallic thread is a light to medium-weight thread suitable for special effects in embroidery.
- When working with metallic threads, the automatic bobbin thread cutter should be deactivated. The other thread cutters shouldn't be used either because the knives are likely to wear off very quickly.
- When using metallic threads, the speed and the upper thread tension should be reduced.





## Bobbin thread

In most cases black or white bobbin thread is used for embroidering. When both sides should have the same look, it is recommended to use the same color for bobbin and upper thread.

- Bobbin Fill is an especially soft and light polyester thread which is suited well to be used as bobbin thread. This special bobbin thread ensures a steady thread tension and an optimal intertwining of the upper and bobbin thread.
- Darning and embroidery threads are fine mercerized cotton threads which are suitable for embroidery on cotton.



## 1.7 Important Embroidery information

### Selecting the embroidery file format

In order that embroidery motifs can be read by the BERNINA embroidery machine, they have to be created by the BERNINA Embroidery software and exported as .EXP file. Besides the actual embroidery file, a .BMP file and an .INF file are generated additionally. The .BMP file allows a preview of the embroidery motif and the .INF file provides the information on the thread colors. **Please note:** If the .INF file is missing, the embroidery motif cannot be displayed in the real color but only in standard colors. In this case, the colors can be entered manually in the color overview of the motif on the machine.

Additionally, following embroidery formats can be read by the machine: .PES, .PEC, .XXX, .PCS, .JEF and .DST. BERNINA International AG doesn't warrant that embroidery motifs which have not been created or converted by the BERNINA Embroidery software can be correctly read and embroidered.

Simple motifs with a low stitch count are suitable for embroidery on fine material. Densely embroidered motifs, e. g. embroidered motifs with multiple color and embroidery direction changes, are suitable for medium and heavy-weight material.

### Embroidery test

For the embroidery test, always use the original material reinforced with the same stabilizer as will be used later. For the embroidery test it is recommended to use the same colors, threads and needles which are planned to be used for the embroidery project.

### The size of the embroidery motif

Embroidery motifs can be enlarged or downsized on the embroidery machine or on the PC using the BERNINA Embroidery software (optional accessory). Enlargements or reductions up to 20% achieve the best results.

### Embroidering motifs by third-party providers

BERNINA recommends uploading embroidery motifs of any file format via the free program «ART-Link» to the machine or a USB stick. Using «ART-Link» ensures that the embroidery motif can be read and embroidered correctly. «ART-Link» can be downloaded for free at [www.bernina.com](http://www.bernina.com).





## 2 Embroidery preparation

### 2.1 Accessory box

#### Removing and attaching the accessory box

The accessory box is fixed to the machine by means of four magnets. When attaching, the drawer has to be integrated in the accessory box.

- > Turn the carrying handle up and hold it in place.
- > Tilt the accessory box slightly forward and pull it off.



- > Close the doors of the accessory box.
- > Attach the accessory box to the machine, having the back towards the machine.

#### Storing accessories

##### NOTICE

#### Incorrect sorting of the bobbin

The silvery sensor surface can get scratched.

- > Make sure that the silvery sensor surfaces are on the right side when sorting the bobbins into the accessory box.

- > Insert the holders (1) for bobbins, feet and needles.
- > Store small parts in the drawer (2), e.g. oiler.
- > Insert the bobbins into the compartment (3) of the accessory box so that the silvery sensor surfaces are on the right side.
- > To remove a bobbin, press the compartment holder down.
- > Place small and medium-sized spool discs onto the pen (4).
- > Store foam pads in the compartment (5).
- > Store the provided needle package in the special compartment (6).
- > Store the embroidery feet (5.5 mm or 9.0 mm) in the holders (1).

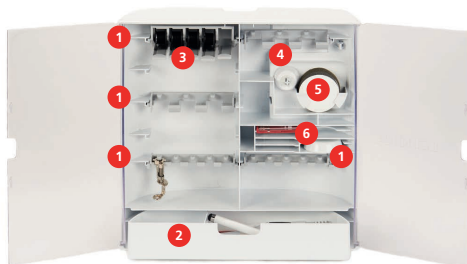

## 2.2 Connection and Switching on

### Connecting the foot control (Optional accessory)

- > Unwind the cable of the foot control to the desired length.



- > Insert the cable of the foot control into the foot control connection.



### Connecting the machine

- > Insert the power cable into the power cord connection.



- > Insert the power cable into the power cord connection.

### Fixing the touchscreen pen

- > Store the touchscreen pen at the magnet holder.



### Switching the machine on

- > Switch on the machine at the main switch to «I».



### Switching on the sewing light

Prerequisite:

- The sewing light has to be activated in the Setup Program.



- > Push the button «Sewing light» to switch the sewing light off.
- > Push the button «Sewing light» again to switch the sewing light on.
  - The sewing light can also be switched on and off in the Setup Program (see page 57).

## 2.3 Foot control (Optional accessory)

### Regulating the speed via the foot control

Via the foot control the speed can be adjusted steplessly.

- > Press the foot control down carefully to start the machine.
- > To embroider faster, press the foot control harder.
- > Release the foot control to stop the machine.



## Raising/Lowering the needle

- > Sink the heel back on the foot control to raise/lower the needle.



## 2.4 Spool pin

### Retractable spool pin

Raise the retractable spool pin



With metallic or other special threads, it is recommend to use the retractable spool pin.

The retractable spool pin is used when special threads are embroidered and it can also be used for bobbin winding while embroidering.

- > To raise the spool pin, push the spool pin down and release it.



- The retractable spool pin appears automatically.
- > To lock the spool pin, turn the spool pin anti-clockwise as far as it will go.
- > To release the lock, turn the spool pin clockwise as far as it will go.
- > To lower the spool pin, push the spool pin down until it clicks into place.

### Inserting foam pad and thread spool

The foam pad prevents the thread from getting hooked at the retractable spool pin.

- > Place the foam pad on the retractable spool pin.

- > Place the thread spool on the spool pin.



### Horizontal spool pin

Placing the foam pad, the thread spool and the spool disc

The spool disc provides an even unwinding of the thread from the thread spool. The spool disc is only used with the horizontal spool pin.

- > Place the foam pad on the spool pin.
- > Place the thread spool on the spool pin.
- > Position the appropriate spool disc on the spool pin so that there is no space between the spool disc and the thread spool.



Using a spool net

The spool net holds the thread on the thread spool and prevents the thread from knotting and breaking.

- > If available, slide the spool net over the thread spool.



## 2.5 Free arm

The BERNINA 500 provides a solidly designed free arm which offers a lot of space for large project on the right of the needle.









- > Touch the icon «Presser foot display/Presser foot selection».



## 2.7 Needle and stitch plate

### Inserting the embroidery needle



Embroidery needles of the type 130/705 H-SUK provide a larger eye and are slightly rounded. This avoids thread abrasion when using Rayon- and cotton embroidery thread. Depending on the embroidery thread use a size No. 70-SUK to No. 90-SUK needle.

- > Raise the needle.
- > Switch off the machine and disconnect it from the power supply.
- > Remove the fitted foot.
- > Loosen the fixing screw for the needle by hand.



- > Pull the needle downwards.
- > Hold the new needle with the flat side to the rear.
- > Slide the needle upwards as far as it will go.
- > Tighten the fixing screw by hand.

## Selecting the embroidery needle in the User Interface

After having changed the needle, it can be checked whether or not it is suitable to be used together with the selected stitch plate.



- > Touch the icon «Needle/Stitch plate selection».
- > Select the attached needle.



- If the selected needle is suitable in combination with the stitch plate, sewing can be started.
- If the selected needle is not suitable in combination with the stitch plate, starting the machine is automatically prevented.

## Selecting the needle type and the needle size

Convenient memory function: To prevent a loss of information, the needle type and the needle size can be saved additionally on the machine. The saved needle type and the saved needle size can be checked at any time.



- > Touch the icon «Stitch plate/Needle selection».

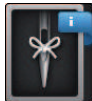

- > Touch the icon «Needle type/Needle size».
- > Select the needle type (1) of the inserted needle.
- > Select the needle size (2) of the inserted needle.

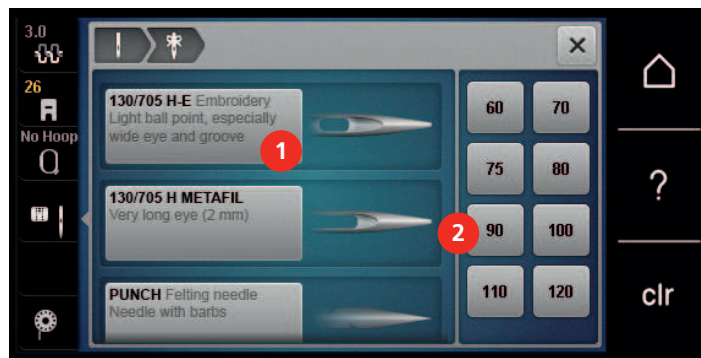

## Adjusting the needle position up/down



- > To pull the thread upwards, touch the icon «Needle up/down».
  - The needle is lowered and raised once.

## Attaching the stitch plate

The stitch plate has a small hole in the needle insertion area. The thread is pulled in and knotted optimally which results in an optimized stitching result.

Prerequisite:

- The machine is switched off and disconnected from the power supply system.
  - The foot and the needle are removed.
- > Press the stitch plate down at the mark back right until it flips up.



- > Remove the stitch plate.
- > Place the openings of the stitch plate (PunchWork, Optional accessory) above the corresponding guide pins and press down until it clicks into place.



## Selecting the stitch plate in the User Interface

After having replaced the stitch plate, it can be checked whether it can be used together with the selected needle.



- > Touch the icon «Stitch plate selection».
- > Select the attached stitch plate (PunchWork, optional accessory).



- If the selected needle is suitable in combination with the stitch plate, embroidering can be started
- If the selected needle is not suitable in combination with the stitch plate, starting the machine is automatically prevented



### Threading the needle

- > Guide the thread through the guides (6/7) above the presser foot.



- > Push the semi-automatic needle-threading lever (8) halfway down and pull the thread behind the grey needle-threading finger/hook to the left (9).

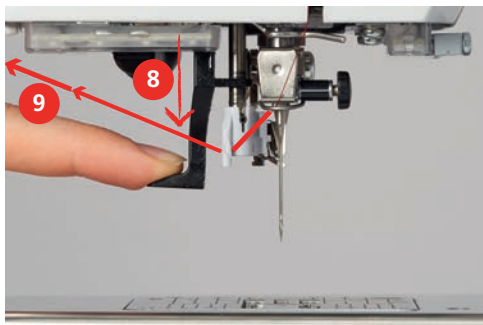

- > Guide the thread from the left to the right in front of the gray needle-threading finger/hook (11).
- > Push the needle-threading lever down as far as it will go (10).
- > Pull the thread from left to right (11) through the needle-threading slot (12) until it clips into the wire hook.
- > Pull the thread over the thread cutter (13) from the back and cut.

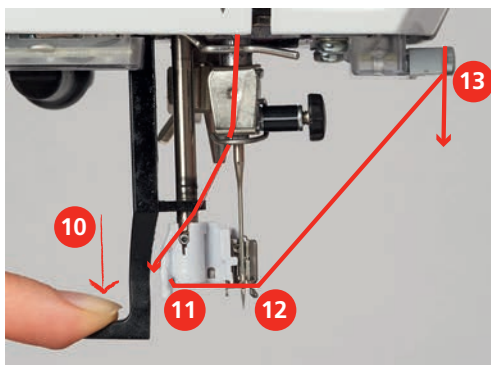

- > Release the needle-threading lever.
  - The thread is pushed through the needle eye.



- > Pull the loop of thread (14) to the rear until the end of the thread is pulled through the needle.

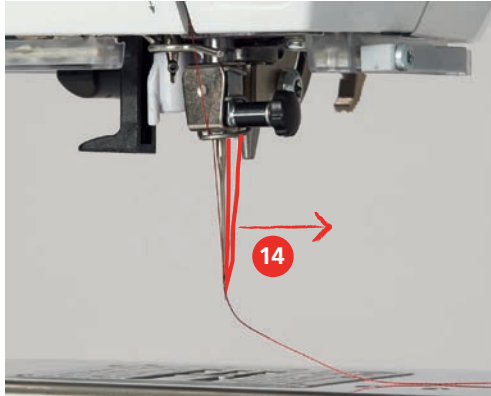

- > Pull the thread below the presser foot and through to the thread cutter (15), and cut it.

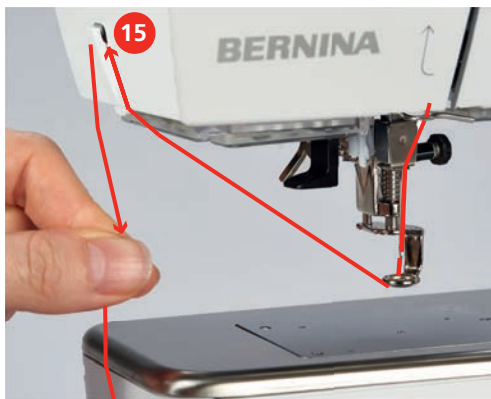

### Winding the bobbin thread



The bobbin thread can be wound while embroidering if the retractable spool pin is used for winding.

Prerequisite:

- The foam pad, the thread spool and the appropriate thread disc are positioned.
- > Attach the empty bobbin on the winding unit so that the silvery sensor surface is down.



- > Guide the thread to the left into the rear thread guide (1).
- > Guide the thread around the thread pretension clockwise (2).
- > Wind the thread clockwise 2 to 3 times around the empty bobbin (3).

- > Pull the thread over the thread cutter at the engaging lever (4) and cut.

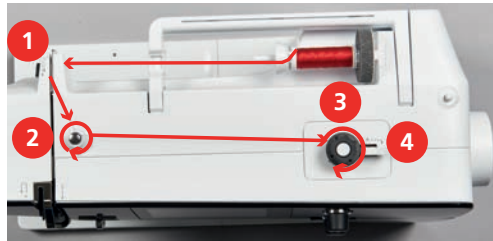

- > Push the engaging lever (5) towards the bobbin.



- The machine winds and the display to wind the bobbin appears.
- > Move the slide on the display using the touchscreen pen or the finger to adjust the winding speed.
- > To stop the winding process, the engaging lever must be pressed to the right.
- > Push the engaging lever towards the bobbin again to continue the winding process.
  - As soon as the bobbin is full, the machine stops the winding process automatically.
- > Remove the bobbin and cut the thread using the thread cutter at the engaging lever.

## Threading the bobbin thread

Prerequisite:

- The needle is raised.
- The machine is switched off and the bobbin cover is opened.
- > Press the bobbin case release at the bobbin case (1).



- > Remove the bobbin case.
- > Remove the bobbin from the bobbin case.





- > Insert the new bobbin so that the silvery sensor surface is facing the back of the bobbin case.



- > Pull the thread into the slot (2) from the left.



- > Pull the thread to the right under the spring (3), then lead the thread under the two thread guides (4) and pull upwards.



- > When inserting into the machine, hold the bobbin case so the thread guide (5) points upwards.

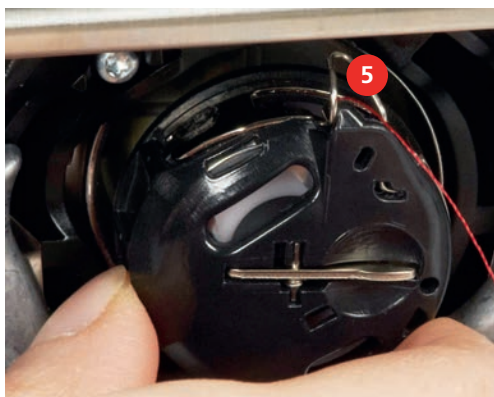

- > Insert the bobbin case.
- > Press onto the center of the bobbin case until it engages.
- > Pull the thread through the thread cutter (6) and cut.

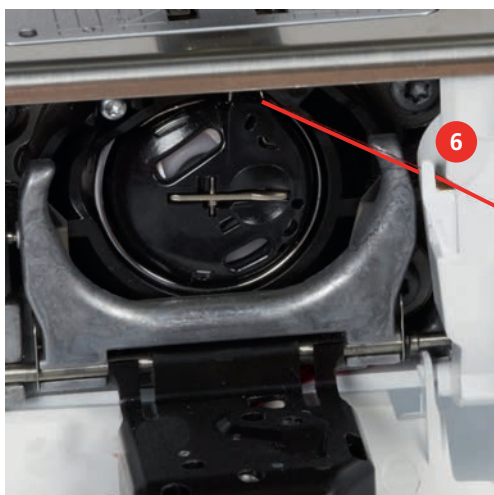

- > Close the bobbin cover.

### Thread-up command

The machine must be ready for embroidery to bring up the bobbin thread. The bobbin thread can be brought up in one step for a manual knotting. If no securing stitches are wanted, it is recommended to deactivate the securing stitches in the Setup.



- > Hold the upper thread.
- > Press the button «Needle up/down».
  - The bobbin thread is brought up automatically.

### Indicating fill level of bobbin thread

As soon as the fill level of the bobbin thread is low, an animation, which indicates that the bobbin thread is running out, appears in the icon «Bobbin thread fill level».



- > Touch the icon «Bobbin thread fill level» to thread the bobbin thread according to the animation.





- > Select an alphabet, embroidery motif or a personal embroidery motif from a file.

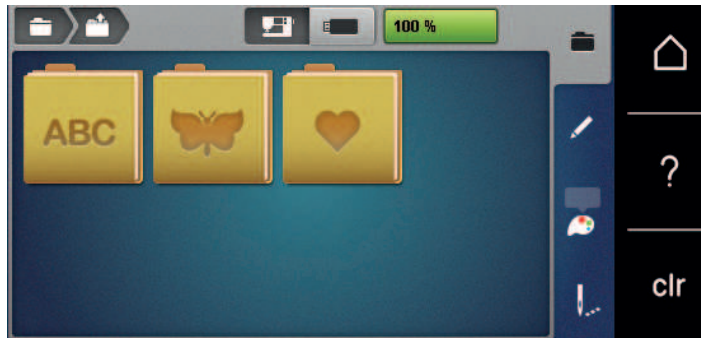

## 2.12 Embroidery hoop

### Overview Embroidery hoop selection

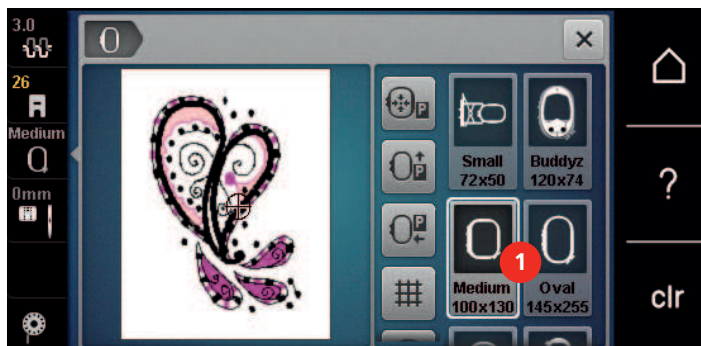

- 1 Hoop selection

### Selecting the embroidery hoop

The best embroidery result is achieved when the smallest possible embroidery hoop for the embroidery motif is selected.

The embroidery motif has a pre-set size which is displayed.

Prerequisite:

- The embroidery motif is selected.



- > Touch the icon «Hoop selection».
  - The machine selects the optimal embroidery hoop according to the size of the embroidery motif automatically. If the pre-set embroidery hoop would not be available, another desired embroidery hoop can be selected. When an embroidery hoop is attached which does not correspond with the selected one, the attached hoop is considered active and the embroidery motif area is displayed accordingly.
- > Select the desired embroidery hoop.

### Tear-away stabilizers

Using a stabilizer ensures more stability of the embroidery project. A tear-away stabilizer suits all woven and non-stretch materials. 1 – 2 layers can be used. Stabilizers are available in different weights. With larger embroidered areas the stabilizer will remain under the embroidery thread. The stabilizer is applied to the wrong side of the fabric with temporary adhesive spray. Carefully tear away excess stabilizer after embroidering.



- > Use adhesive spray to adhere stabilizer if necessary.
- > For material with a pile, reinforce with additional, suitable stabilizer on the wrong side.
- > Place all the layers together into the embroidery hoop.
- > After dissolving, lay the motif down flat and let dry.

### Preparing the embroidery hoop

The embroidery hoop consists of an outer and an inner hoop. There is a corresponding template for every hoop. The area to be embroidered is marked in 1 cm (0.39 inch) squares. The center and corner points are marked with holes. The required marks can be transferred to the material.

- > Mark the center of an embroidery motif on the fabric, using a water-soluble pen.

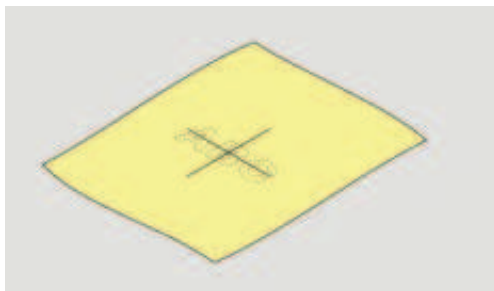

- > Loosen the screw on the outer hoop.
- > Remove the inner hoop.
- > Make sure that the arrows marks of both hoops match.
- > Attach the template holder.
- > Place the template in the inner hoop, so the BERNINA logo is at the front edge at the arrow mark until it clicks into place.

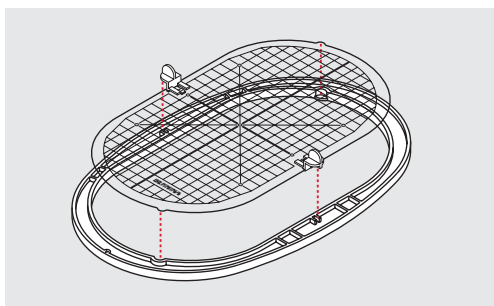

- > Place the material under the inner hoop.
- > Line up the marked center point on the center of the template.
- > Place the material and the inner hoop on the outer hoop so that the arrows of both hoops match.

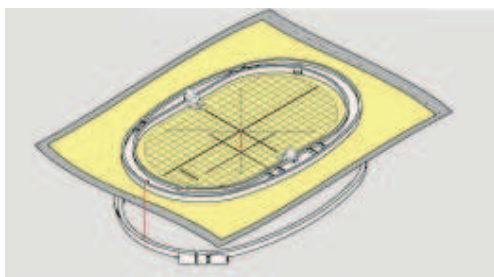

- > Fit the hoops into each other; ensure that the material does not move.
- > Hoop the fabric to be embroidered tightly.
- > Tighten the screw.
- > Remove the template from the hoop by using the template holder.
- > To avoid scratches on the free arm, press the inner hoop into the outer hoop so that the inner hoop including the fabric protrudes downwards by up to 1 mm.

## Attaching the hoop

- > Raise the needle.
- > Raise the embroidery foot.
- > Hold the hoop with the right side of the fabric up with the attaching mechanism to the left.
- > Position the hoop below the embroidery foot.
- > Press both attaching mechanisms (1) of the hoop towards each other.
- > Position the embroidery hoop (2) above the bracket of the embroidery arm.
- > Press the hoop down until it clicks in position.
- > Release the attaching mechanism (1).

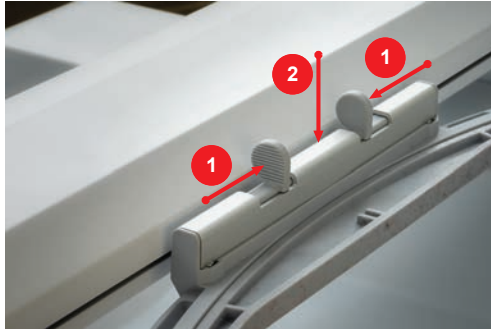

- > Press the attaching mechanisms of the hoop towards each other to remove the hoop.
- > Remove the hoop.

## Overview embroidery functions

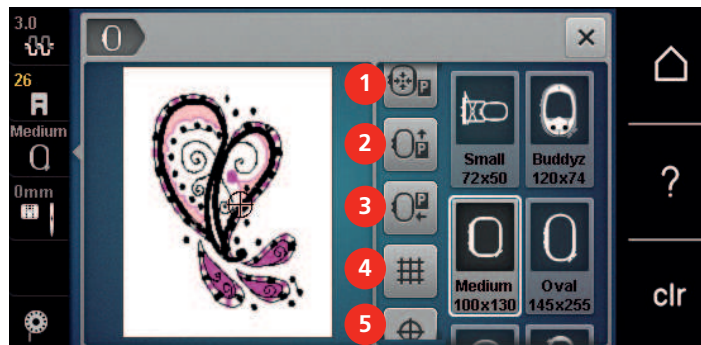

- |   |   |   |  |
|---|---|---|--|
| 1 | Centering the embroidery hoop to the needle | 4 | Grid on/off                                |
| 2 | Moving the embroidery hoop to the back      | 5 | Center of embroidery motif                 |
| 3 | Moving the embroidery hoop to the left      | 6 | Virtual positioning (appears by scrolling) |

## Center the needle to the embroidery hoop

Relocating the embroidery hoop facilitates threading when the needle is close to the embroidery hoop.



- > Touch the icon «Embroidery hoop display/Embroidery hoop selection».



- > Touch the icon «Center the needle to the embroidery hoop».
- > Threading the upper thread.



- > Push the button «Start/Stop» to move the embroidery hoop back to the last position.

### Moving the hoop to the back

To facilitate changing the bobbin, it is recommended to move the hoop to the back before threading. This makes it easier to open the bobbin cover.



- > Touch the icon «Embroidery hoop display/Embroidery hoop selection».

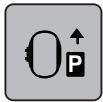

- > Touch the icon «Move the hoop to the back».
- > Thread the bobbin thread (see page 40).



- > Push the button «Start/Stop» to move the embroidery hoop back to the last position. If necessary, pull the upper thread back.

### Moving the embroidery arm to the left



- > Touch the icon «Embroidery hoop display/Embroidery hoop selection».
- > Remove the embroidery hoop.



- > Touch the icon «Moving the embroidery hoop to the left».
- An animation «Remove the embroidery hoop» appears.



- > Touch the icon «Confirm».
- The embroidery arm moves to the left into the parking position.

### Grid on/off

When the center of the hoop and the grid are displayed, the embroidery motif can be positioned more exactly.



- > Touch the icon «Embroidery hoop display/Embroidery hoop selection».

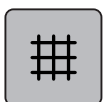

- > Touch the icon «Grid on/off» to display the center of the hoop on the display.
- > Touch the icon «Grid on/off» again to display the grid.
- > Touch the icon «Grid on/off» again so that the center of the hoop and the grid disappear.

### Locating the center of the embroidery motif

The embroidery hoop is positioned so that the needle is exactly above the center of the embroidery motif or the motif begin.



- > Touch the icon «Embroidery hoop display/Embroidery hoop selection».



- > Touch the icon «Center of embroidery motif» or



- > push the button «Center of embroidery motif» to position the embroidery hoop so that the needle is exactly above the center of the embroidery motif.
- > Touch the icon «Center of embroidery motif» again or
- > push the button «Center of embroidery motif» again to position the embroidery hoop so that the needle is exactly above the pattern begin.





## 3 Setup Program

### 3.1 Embroidery settings

#### Adjusting the upper thread tension

Changes to the upper thread tension in the Setup Program affect all of the embroidery motifs. The setting in the Setup Program is retained after the machine is switched off.



> Touch the icon «Home».



> Touch the icon «Setup Program».



> Touch the icon «Embroidery settings».



- > Touch the icon «Change upper thread tension».
- > To increase the upper thread tension, slide the slider upwards or touch the icon «+».
- > To decrease the upper thread tension, slide the slider downwards or touch the icon «-».

#### Adjusting the maximum embroidering speed

You can use this function to reduce the maximum speed.



> Touch the icon «Home».



> Touch the icon «Setup Program».



> Touch the icon «Embroidery settings».



- > Touch the icon «Change maximum speed».
- > To decrease the embroidery speed, slide the slider to the left or touch the icon «-».
- > To increase the maximum embroidery speed, slide the slider to the right or touch the icon «+».

#### Setting the embroidery motif position when opening

As the default setting, opened embroidery motifs are always displayed in the center of the hoop. You can use the switch «Restore saved embroidery motif position» to set that embroidery motifs are opened at the position in the hoop at which they had been saved in the BERNINA stitch software.



> Tap «Home».



> Touch the icon «Setup Program».



> Touch the icon «Embroidery settings».



> Touch the icon «Center the embroidery motif».



- > To open the embroidery motif at the saved position, set the switch «Restore saved embroidery motif position» to «I».
- > To open the embroidery motif in the center of the hoop, set the switch «Restore saved embroidery motif position» to «0I».

## Calibrating the hoop

The calibration of the embroidery hoop is the coordination of the needle to the center of the embroidery hoop.

Prerequisite:

- The embroidery module is connected.
- The hoop is fitted with the corresponding embroidery pattern.



> Touch the icon «Home».



> Touch the icon «Setup Program».



> Touch the icon «Embroidery settings».



- > Touch the icon «Calibrating the hoop».
- > Use the arrow icons on the display to move the needle precisely to the center of the pattern.



> Accept the needle position using the icon «Confirm».

### Entering the fabric thickness

If the fabric thickness, as for e.g. toweling is more than 4 mm (0.15 inch) it is recommended to select 7.5 mm (0.29 inch) or 10 mm (0.39 inch). The thicker the fabric, the slower the embroidery speed of the machine. When the machine is switched off, the alterations are reset to the default setting 4 mm (0.15 inch).



> Touch the icon «Home».



> Touch the icon «Setup Program».



> Touch the icon «Embroidery settings».



> Touch the icon «Select fabric thickness».  
> Select fabric thickness.

### Function thread away on/off

To pull the thread end out of the fabric being cut, the function must be activated. For embroidery motifs with long stitches, it is recommended to deactivate the function thread away. When the distance between the presser foot and the embroidery hoop is too short, the function is not carried out.



> Touch the icon «Home».



> Touch the icon «Setup Program».



> Touch the icon «Embroidery settings».



> Touch the icon «Thread away».



> To activate the function thread away, set the switch to «1».  
> To deactivate the function thread away, set the switch to «0».

### Programming securing stitches (Smart Secure)

Embroidery motifs are programmed with or without securing stitches. The machine detects if no securing stitches are programmed and adds these.



> Touch the icon «Home».



> Touch the icon «Setup Program».



> Touch the icon «Embroidery settings».



> Touch the icon «Securing stitches on/off».



- > To switch off securing stitches at the start, move the switch in the upper right-hand area to «0».
  - If the embroidery motif has programmed securing stitches, they will be embroidered.
  - If the embroidery motif doesn't have any programmed securing stitches, none are embroidered.
- > To switch on securing stitches at the start, move the switch in the upper right-hand area to «I».
  - If the embroidery motif has programmed securing stitches, they will be embroidered.
  - If the embroidery motif doesn't have any programmed securing stitches, the securing stitches are added and will be embroidered.
- > To switch off securing stitches at the end, move the switch in the lower right-hand area to «0».
  - If the embroidery motif has programmed securing stitches, they will be embroidered.
  - If the embroidery motif doesn't have any programmed securing stitches, none are embroidered.
- > To switch on securing stitches at the end, move the switch in the lower right-hand area to «I».
  - If the embroidery motif has programmed securing stitches, they will be embroidered.
  - If the embroidery motif doesn't have any programmed securing stitches, the securing stitches are added and will be embroidered.

### Adjusting the thread cut

The settings for the thread cut can be customized. Deactivate the thread cut after a color change (1) or adjust the length of the connecting stitch (3). The machine does the cutting of the connecting threads at the determined length for you. First, set the length from which the connecting stitches are cut, and then select the embroidery motif.



The length of the connecting thread can be adjusted between 1 mm and 15 mm, the default setting is 6 mm. This means that all connecting stitches longer than 6 mm are cut automatically. If the value is reduced to 1 mm, more thread cuts are carried out, it takes longer to embroider and more loose thread ends can be seen on the wrong side of the fabric, especially when the function 'Thread-away' is activated too. On the right side of the fabric there will be practically none or merely very short connecting stitches which results in a wonderful stitch formation. Reducing the length of the thread cut to 1 mm is particularly of advantage when embroidering texts where usually many short connecting threads occur. When both sides of the embroidery motifs are visible, it may be reasonable to not reduce the length of the thread cut so much so that there won't be too many loose thread ends on the wrong side of the fabric. Loose ends get sewn over and can hardly be removed afterwards.



> Touch the icon «Home».



> Touch the icon «Setup Program».



> Touch the icon «Embroidery settings».



> Touch the icon «Thread cut settings».

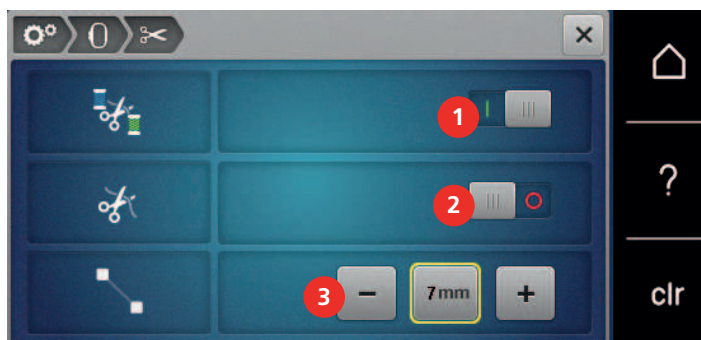

- > To switch off the automatic thread cut before changing the thread, move the switch in the upper area of the display (1) to «0».
- > To switch on the automatic thread cut before changing the thread, move the switch in the upper area of the display (1) to «I».
- > To stop the machine for the manual thread cut, move the switch in the central area of the display (2) to «I».
- The machine stops after approx. seven stitches; the thread can be cut by hand.
- > To not stop the machine for the manual thread cut, move the switch in the central area of the display (2) to «0».
- > To set the length from which the connecting stitches are cut, touch the icons «-» or «+» (3).

### Changing the measuring unit

The unit of measurement in the embroidery mode can be changed from mm to inches. The default setting is mm.



> Touch the icon «Home».



> Touch the icon «Setup Program».



> Touch the icon «Embroidery settings».



- > Touch the icon «Change measuring unit».
- > To change the unit of measurement in embroidery mode to inches, touch the icon «Inch» (1).
- > To change the unit of measurement in embroidery mode to mm, touch the icon «mm» (2).

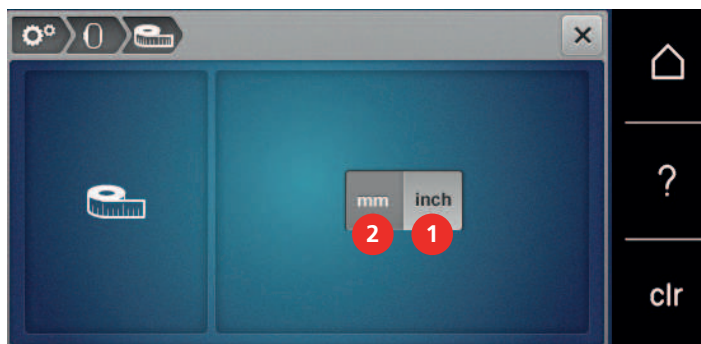

### 3.2 Selecting personal settings



> Touch the icon «Home».



> Touch the icon «Setup Program».



> Touch the icon «Own settings».



- > Select the required display color and background.
- > To change the welcome message, touch the text field above the color settings.
- > Enter the welcome message.
- > For upper-case letters, touch the icon «ABC» (default setting).
- > For lower-case letters, touch the icon «abc».
- > For numbers and mathematical symbols, touch the icon «123».
- > For special characters, touch the icon «@&!».
- > To completely delete the text, touch inside the text field above the keyboard.
- > To delete individual letters, touch the icon «DEL».



> To accept the text, touch the icon «Confirm».



> Close the window.



> Touch the icon «Home».  
– The welcome message is saved.

### 3.3 Monitoring functions

#### Activating the upper thread indicator



> Touch the icon «Home».



> Touch the icon «Setup Program».



> Touch the icon «Monitoring settings».



- > To switch off the upper thread indicator, move the switch in the upper area to «0».
- > To switch on the upper thread indicator, move the switch in the upper area to «I».

### Activating the bobbin thread indicator



> Touch the icon «Home».



> Touch the icon «Setup Program».



> Touch the icon «Monitoring settings».



- > To switch off the lower thread indicator, move the switch in the lower area to «0».
- > To switch on the lower thread indicator, move the switch in the lower area to «I».

### 3.4 Activating the audio signals



> Touch the icon «Home».



> Touch the icon «Setup Program».



- > Touch the icon «Audio signals».
- > Touch the switch (1) to deactivate any audio signals in general.
- > Touch the switch (1) again to activate any audio signals in general.
- > In the section (2) touch the icons «1 – 4» to set up the desired signal for the selection of an embroidery motif.



- > In the section (2) touch the icon «Loudspeaker» to deactivate the signal for the selection of an embroidery motif.
- > In the section (3) touch the icons «1 – 4» to activate the signal for the selection of functions.



> In the section (3) touch the icon «Loudspeaker» to deactivate the signal for the selection of functions.





## 3.5 Machine settings

### Selecting a language



> Tap «Home».



> Tap «Setup Program».



> Tap «Machine settings».



> Tap «Language selection».  
> Tap the required language.

### Adjusting the brightness of the display

The brightness of the display can be set to meet your individual needs.



> Touch the icon «Home».



> Touch the icon «Setup Program».



> Touch the icon «Machine settings».



> Touch the icon «Adjust brightness».  
> To change the display brightness, slide the slider in the upper area of the display to the left or right, or touch the icons «+» or «-».

### Adjusting the sewing light

You can set the brightness of the sewing light to meet your individual needs.



> Touch the icon «Home».



> Touch the icon «Setup Program».



> Touch the icon «Machine settings».



> Touch the icon «Adjust brightness».



- > To switch off the sewing light, move the switch to «0».
- > To switch on the sewing light, move the switch to «I».
- > To set the brightness of the sewing light, slide the slider in the lower area of the display to the left or right, or touch the icons «+» or «-».

### Checking the firmware version

The machine's firmware and hardware versions are displayed.



- > Touch the icon «Home».



- > Touch the icon «Setup Program».



- > Touch the icon «Machine settings».



- > Touch the icon «Information».



- > Touch the icon «Firmware and Hardware Information».

### Reviewing the total number of stitches

The total number of stitches of the machine as well as the number of stitches since the last service carried out by the specialized BERNINA dealer are displayed.



- > Touch the icon «Home».



- > Touch the icon «Setup Program».



- > Touch the icon «Machine settings».



- > Touch the icon «Information».



- > Touch the icon «Firmware and Hardware Information».



## Registering details of the dealer

The contact details for your specialized BERNINA dealer can be entered.



> Touch the icon «Home».



> Touch the icon «Setup Program».



> Touch the icon «Machine settings».



> Touch the icon «Information».



> To enter the dealer details, touch the icon «Dealer data».



> To enter the company name of the specialized BERNINA dealer, touch the icon «Company name».



> To enter the address of the specialized BERNINA dealer, touch the icon «Address».



> To enter the telephone number for the specialized BERNINA dealer, touch the icon «Telephone».



> To enter the website or e-mail address for the specialized BERNINA dealer, touch the icon «Internet».

## Saving Service data

The service data regarding the current status of the machine can be saved on the BERNINA USB stick (optional accessory) and provided to the specialized BERNINA dealer.

> Insert the BERNINA USB stick (optional accessory) with enough free capacity into the machine's USB slot.

> Touch the icon «Home».



> Touch the icon «Setup Program».



> Touch the icon «Machine settings».





> Touch the icon «Information».



> Touch the icon «Service data».

> Touch the icon «LOG».

– The icon "LOG" has a white frame.

> Ensure that the white frame is no longer displayed and remove the BERNINA USB stick (optional accessory).

### Back to basic setting

**ATTENTION:** Using this function will delete all individually made settings.



> Touch the icon «Setup Program».



> Touch the icon «Machine settings».



> Touch the icon «Default settings».



> Touch the icon «Default setting embroidery».



> Touch the icon «Confirm» and restart the machine to restore all default settings.

### Deleting user data

Motifs which are not needed anymore can be deleted so that there will be more capacity for new motifs.



> Touch the icon «Home».



> Touch the icon «Setup Program».



> Touch the icon «Machine settings».



> Touch the icon «Default settings».



> Touch the icon «Delete personal embroidery motifs».



> Touch the icon «Confirm» to delete all embroidery motifs from the personal memory.

## Deleting motifs on the BERNINA USB Stick

When motifs which won't be needed anymore are saved on the BERNINA USB Stick (Optional accessory), the stick can be connected to the machine and the data can be deleted.

- > Insert the BERNINA USB Stick (Optional accessory) into the den USB port of the machine.
- > Touch the icon «Home».



- > Touch the icon «Setup Program».



- > Touch the icon «Machine settings».



- > Touch the icon «Default settings».



- > Touch the icon «Delete data from USB Stick».



- > Touch the icon «Confirm» to delete all data on the BERNINA USB Stick (optional accessory).



## Updating the machine Firmware

The machine's current firmware and detailed step-by-step instructions for the update process can be downloaded from [www.bernina.com](http://www.bernina.com). In general, personal data and settings are automatically transferred during a firmware update. For reasons of safety, it is also recommended to save data and settings on a BERNINA USB stick (optional accessory) before the firmware update is started. If personal data and settings should get lost during a firmware update, they can be transferred to the machine again afterwards.

### NOTICE

The BERNINA USB stick (optional accessory) has been removed too early

Firmware has not been updated and the machine cannot be used.

- > Remove the BERNINA USB stick (optional accessory) only after the update has been completed successfully.

- > Insert the BERNINA USB stick (optional accessory), FAT32 formatted, providing the latest software into the port.

- > Touch the icon «Home».



- > Touch the icon «Setup Program».



- > Touch the icon «Machine settings».



- > Touch the icon «Maintenance/Update».



## Setup Program



> Touch the icon «Update the machine».



> Touch the icon «Save data on USB stick».  
– The icon is checkmarked in green.



> To start the firmware update, touch the icon «Update».

### Recovering saved data

If personal data and settings after a software update are not available anymore, they can be transferred to the machine again afterwards.

#### NOTICE

The BERNINA USB stick (optional accessory) has been removed too early

Saved data cannot be transferred and the machine cannot be used.

> Remove the BERNINA USB stick (optional accessory) only after the saved data has been transferred successfully.

> Insert the BERNINA USB stick (optional accessory) providing the saved data and settings into the USB port of the machine.



> Touch the icon «Home».



> Touch the icon «Setup Program».



> Touch the icon «Machine settings».



> Touch the icon «Maintenance/Update».



> Touch the icon «Update the machine».



> Touch the icon «Transfer saved data to machine».  
– The icon is checkmarked in green.

## Cleaning the thread catcher

The chapter «Maintenance and cleaning» provides additional illustrated step-by-step instructions for this.



> Touch the icon «Home».



> Touch the icon «Setup Program».



> Touch the icon «Machine settings».



> Touch the icon «Maintenance/Update».



> Touch the icon «Clean thread catcher».  
> Clean the thread catcher according to the instructions on the display.

## Lubricating the machine



### Electronically driven components

Risk of injury near the needle and the hook.

> Switch the machine off and disconnect it from the power supply system.



### Lubricating the hook

Too much oil can pollute the fabric and the thread.

> After lubricating, sew/embroider a test piece first.

The Setup Program provides animations how the machine has to be oiled. In chapter «Maintenance and cleaning» there are additional illustrated step-by-step instructions. Always use BERNINA oil to lubricate.



> Touch the icon «Home».



> Touch the icon «Setup Program».



> Touch the icon «Machine settings».



> Touch the icon «Maintenance/Update».



> Touch the icon «Lubricate the machine».  
> Lubricate the machine according to the instructions on the display.

## Packing the embroidery module

To pack the embroidery module into the original packaging without moving the embroidery arm manually, the embroidery arm needs to be brought to its packing position.

Prerequisite:

- The embroidery module is connected with the machine.



> Touch the icon «Home».



> Touch the icon «Setup Program».



> Touch the icon «Machine settings».



> Touch the icon «Maintenance/Update».



> Touch the icon «Packing position for embroidery module».  
> Follow the instructions on the display.



## 4 System settings

### 4.1 Calling up the Tutorial

The Tutorial provides information and explanations on different sections concerning embroidering.



- > Touch the icon «Home».



- > Touch the icon «Tutorial».
- > Select the desired topic to get information.

### 4.2 Calling up the embroidery consultant

The Embroidery Consultant informs you about decision support for embroidery projects. After entering the desired embroidery project and the fabric, suggestions for the suitable needle and the suitable embroidery foot are displayed.

Prerequisite:

- Embroidery mode is active.



- > Touch the icon «Home».



- > Touch the icon «Embroidery consultant».
- > Select the embroidering project.
- > Select the fabric on which you want to embroider.
- > Touch the icon «Confirm».
  - If an embroidery motif has already been selected, a warning appears stating that this will be overwritten.

### 4.3 Using eco mode

For a longer work stoppage, the machine can be put into energy-saving mode.



- > Touch the icon «Home».



- > Touch the icon «eco mode».
  - The display goes to sleep. The power consumption is reduced and the sewing light is off.
- > To exit energy-saving mode, touch the eco symbol on the display.
  - The machine is ready for use.

### 4.4 Calling up the Help



- > Touch the window in the display where help is needed.
- > Touch the icon «Help» to start the help mode.
- > Touch the icon in the display where help is needed.
  - Assistance concerning the selected icon is displayed.

#### 4.5 Cancelling any alterations with «clr»

Any alterations to motifs can be reset to default setting. Exceptions are saved motifs which have been filed in the personal memory and monitoring functions.



> Touch the icon «clr».



## 5 Creative embroidering

### 5.1 Overview embroidering

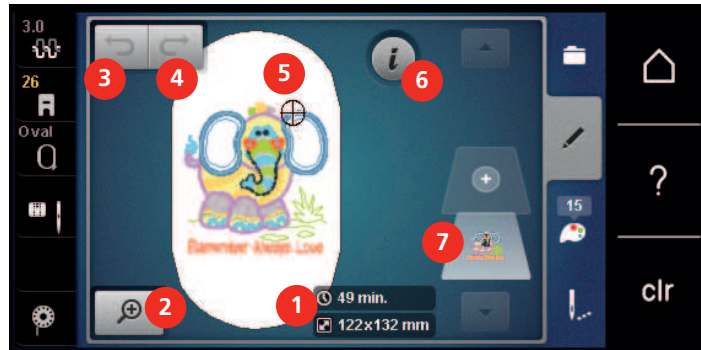

- |   |   |   |                         |
|---|---|---|-------------------------|
| 1 | Embroidery time/Embroidery motif size in mm or inch         | 5 | Area to be embroidered  |
| 2 | Scaling up, downsizing and moving the embroidery motif view | 6 | «i»-Dialog              |
| 3 | Undoing entries   | 7 | Embroidery motif layers |
| 4 | Redoing entries   |   |                         |

### 5.2 Selecting and changing the embroidery motif



- > Touch the icon «Selection».



- > Touch the icon «Upload embroidery motif».
- > Select a new embroidery motif.

### 5.3 Checking the embroidery time and the embroidery motif size

In the display «Editing» at lower right (1), the estimated embroidery time is indicated in minutes and the width and height of the embroidery motif is indicated in millimeters.

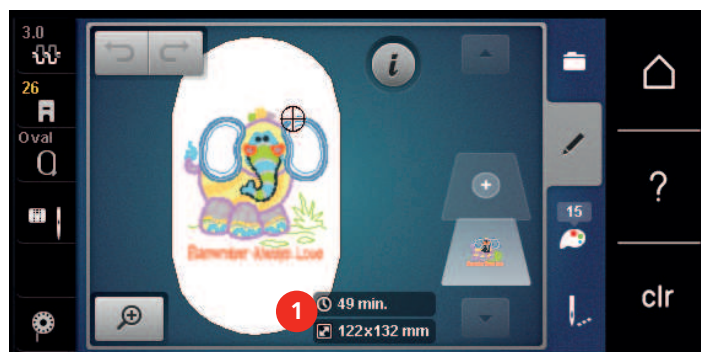

### 5.4 Regulating the speed

The sewing speed can be adjusted infinitely variable with the slide.

- > Move the slide to the left to reduce the sewing speed.
- > Move the slide to the right to increase the sewing speed.

## 5.5 Editing the embroidery motif

### Overview Editing embroidery motif

- > To edit an embroidery motif, select the embroidery motif.
- > Touch the icon **i**-Dialog.



- |   |                         |    |   |
|---|-------------------------|----|---|
| 1 | Zoom out                | 10 | Mirror image up/down  |
| 2 | Zoom in                 | 11 | Duplicating   |
| 3 | Moving the view         | 12 | Endless Embroidery  |
| 4 | Moving the motif        | 13 | Deleting  |
| 5 | Moving the motif        | 14 | Checking the motif size   |
| 6 | Rotating the motif      | 15 | Curve text (only with the selected alphabet, can be viewed by scrolling)            |
| 7 | Changing the size       | 16 | Group the embroidery motifs (can be viewed by scrolling)                            |
| 8 | Pinpoint placement      | 17 | Changing the sequence within an embroidery motif combination (appears by scrolling) |
| 9 | Mirror image left/right | 18 | Change the stitch type/stitch density (can be viewed by scrolling)                  |

### Scaling up the embroidery motif view

The view of the embroidery motif can be scaled up. In addition to that, the view can be adjusted with or without changing the embroidery position.

- > Select an embroidery motif.
- > Touch the icon «Zoom in» to edit the view of the embroidery motif.



- > Touch the icon «Zoom in» 1 to 4 times to enlarge the view of the embroidery motif gradually.



- > Touch the icon «Zoom out» 1 to 4 times to get back to the Edit Mode.

### Downsizing the embroidery motif view

The view of the embroidery motif can be downsized. In addition to that, the view can be adjusted with or without changing the embroidery position.

- > Select an embroidery motif.
- > Touch the icon «Zoom in» to edit the view of the embroidery motif.



- > Touch the icon «Zoom out» 1 to 4 times to downsize the view of the embroidery motif gradually.

### Moving the embroidery motif view

The view of the embroidery motif can be moved. In addition to that, the view can be adjusted with or without changing the embroidery position.

- > Select an embroidery motif.
- > To activate the icon «Move the view», touch the icon «Zoom in».

- The icon «Move the view» is active (dark grey)

- > Move the view of the embroidery motif.
- The embroidery position is not altered.

- > Touch the icon «Zoom out» to get back to the Edit Mode.

### Moving the embroidery motif in enlarged view

The view of the embroidery motif can be moved. In addition to that, the view can be adjusted with or without changing the embroidery position.

- > Select an embroidery motif.
- > To display the icon «Move the embroidery motif», touch the icon «Zoom in».

- > Touch the icon «Move the stitch pattern».
- The icon turns dark gray.

- > Move the view of the embroidery motif.
- The embroidery position is altered.

- > Touch the icon «Zoom out» to get back to the Edit Mode.

### Moving the embroidery motif

- > Select an embroidery motif.
- > Touch the icon «i»-Dialog.



- > Touch the icon «Move the stitch pattern».
- > Turn the «Upper Multifunction knob» to move the embroidery motif horizontally in 1/10-mm steps.
- > Turn the «Lower Multifunction knob» to move the embroidery motif vertically in 1/10-mm steps or
- > touch the embroidery motif, keep it pressed and move it as you like.
- The relocation is indicated in the yellow-framed icons.

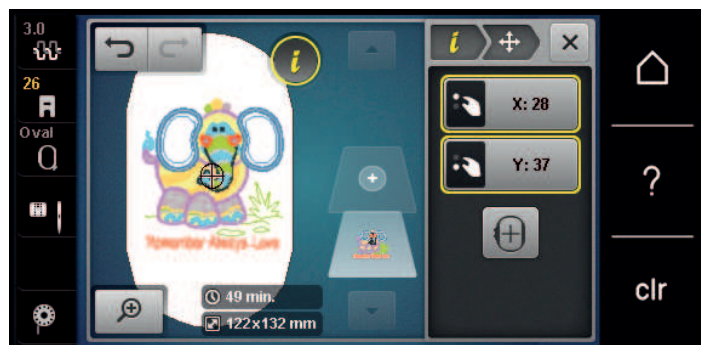



- > Touch the icon «Center of the embroidery motif».
- The embroidery motif is repositioned in the center of the embroidery hoop.

### Rotating motif



- > Select an embroidery motif.
- > Touch the icon «i»-Dialog.

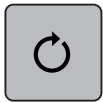

- > Touch the icon «Rotate the motif».
- > Turn the «Upper Multifunctional knob» or the «Lower Multifunctional knob» to the right to rotate the embroidery motif clockwise.
- > Turn the «Upper Multifunctional knob» or the «Lower Multifunctional knob» to the left to rotate the embroidery motif counter-clockwise.



- > Touch the icon «Rotate the motif +90°» to rotate the embroidery motif in 90°-steps.

### Altering the embroidery motif size proportionally



Enlargements or reductions of the motif size up to maximum 20% achieve the best results.

If the motif size is to be altered by more than 20%, the motif should be adapted in a separate embroidery software and then reloaded onto the machine.



- > Select an embroidery motif.
- > Touch the icon «i»-Dialog.



- > Touch the icon «Alter the embroidery size».



- > To change the embroidery motif size proportionally, the icon «Retain proportions» must have a white frame.
- Only touch the icon «Retain proportions» when the icon does not have a white frame.
  - The icon «Retain proportions» has a white frame.



- > Turn the «Upper/Lower Multifunction knob» to the right to scale up the embroidery motif proportionally.
- > Turn the «Upper/Lower Multifunction knob» to the left to downsize the embroidery motif proportionally.

## Altering the embroidery motif size disproportionately



Enlargements or reductions of the motif size up to maximum 20% achieve the best results.

If the motif size is to be altered by more than 20%, the motif should be adapted in a separate embroidery software and then reloaded onto the machine.



- > Select an embroidery motif.
- > Touch the icon «i»-Dialog.



- > Touch the icon «Alter the embroidery size».



- > To change the embroidery motif size disproportionately, the icon «Retain proportions» must not have a white frame.
- Only touch the icon «Retain proportions» when the icon has a white frame.
  - The icon «Retain proportions» does not have a white frame.



- > To make the embroidery motif wider, turn the «Upper multifunction knob» clockwise.
- > To make the embroidery motif narrower, turn the «Upper multifunction knob» anti-clockwise.
- > To make the embroidery motif longer, turn the «Lower multifunction knob» clockwise.
- > To make the embroidery motif shorter, turn the «Lower multifunction knob» anti-clockwise.

## Mirroring embroidery motifs

Embroidery motifs can be mirror-imaged both vertically and horizontally.



- > Select an embroidery motif.
- > Touch the icon «i»-Dialog.



- > Touch the icon «Mirror image left/right» to mirror the embroidery motif vertically.



- > Touch the icon «Mirror image up/down» to mirror the embroidery motif horizontally.

## Bending the text

Texts can be arranged and designed arc-shaped.

- > Create an alphabet embroidery motif.



> Touch the icon «i»-Dialog.



- > Touch the icon «Bend text».
- > Turn the «Upper Multifunctional knob» to alter the distance between the characters in millimeter-steps.
- > Turn the «Lower Multifunctional knob» to the left or to the right to bend the lettering upwards or downwards.

### Changing the stitch type

If the satin stitches are too long, they can be changed to step stitches.



- > Select an embroidery motif.
- > Touch the icon «i»-Dialog.



> Touch the icon «Change the stitch type».



- > Touch the switch in the upper section of the display (1) to change the satin stitch to the step stitch.
- > Adjust the desired stitch length (2) with the icons «-» or «+».

### Altering the stitch density

If the satin stitches are embroidered too densely, the stitch density can be adjusted.



- > Select an embroidery motif.
- > Touch the icon «i»-Dialog.



- > Touch the icon «Change the stitch type».
- > Adjust the desired stitch density (1) with the icons «-» or «+».





## Checking the embroidery motif size and position

It can be checked whether or not the embroidery motif matches the designated position/location on the fabric. Points which are beyond the embroidery hoop are not traveled to.

- > Select the embroidery motif.
- > Touch the icon «i»-Dialog.

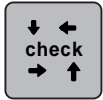

- > Touch the icon «Check the embroidery motif size» or



- > push the button «Check the embroidery motif size».
  - The embroidery hoop travels all the way until the needle is at the position as it is indicated in the display.
- > Touch the icon «Corner top left» to select the top left corner of the embroidery motif.
  - The embroidery hoop travels all the way until the needle is at the position as it is indicated in the display.
- > Touch the icon «Corner top right» to select the top right corner of the embroidery motif.
  - The embroidery hoop travels all the way until the needle is at the position as it is indicated in the display.
- > Touch the icon «Corner bottom left» to select the bottom left corner of the embroidery motif.
  - The embroidery hoop travels all the way until the needle is at the position as it is indicated in the display.
- > Touch the icon «Corner bottom right» to select the bottom right corner of the embroidery motif.
  - The embroidery hoop travels all the way until the needle is at the position as it is indicated in the display. If the embroidery motif hasn't been positioned correctly yet, the position can be altered via the «Upper/Lower Multifunctional knobs» and the complete embroidery positions can be checked again.

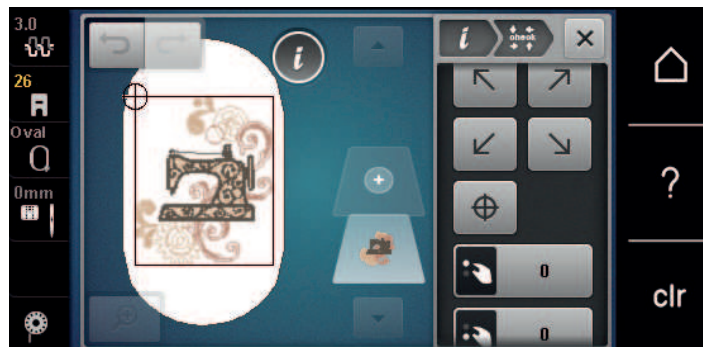

- > Touch the icon «Center of the embroidery motif» or



- > push the button «Center of the embroidery motif» to bring the needle to the center of the embroidery motif.
- > Turn the «Upper Multifunctional knob» to move the embroidery motif horizontally.
- > Turn the «Lower Multifunctional knob» to move the embroidery motif vertically.

## Endless embroidery

When embroidering a trim, it is advantageous to use the «Mega Hoop» (optional accessory). The embroidering project therefore does not have to be re-clamped as frequently. We recommend marking guide lines on the fabric and using the pattern when clamping and re-clamping in the hoop. In doing so, the guide lines must run parallel to the pattern. The following example uses the enclosed «Oval Hoop».

- > Select an embroidery motif.
- > Touch the icon «i»-Dialog.



- > Touch the icon «Embroider trims».
  - The embroidery motif is duplicated to the optimum number, suitable for the hoop.
  - The reference points, which are required when re-clamping the fabric, are inserted.

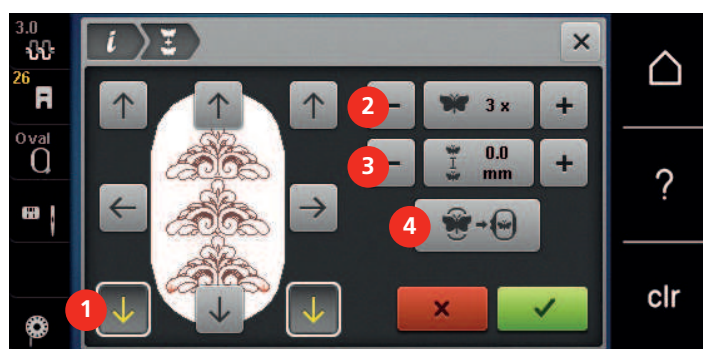

- > If required, use the arrow icons (1) to insert additional reference points.
- > Turn the «Upper multifunction knob» or touch the icons «-/+» (2) to set the number of embroidery motifs.
- > Turn the «Lower multifunction knob» or touch the icons «-/+» (3) to set the distance between the embroidery motifs.



- > Touch the icon «Adapt embroidery motif size to the hoop» (4) to automatically adapt all of the embroidery motifs to the hoop.



- > Touch the icon «Confirm».



- > Touch the icon «i»-Dialog.



- > Touch the icon «Embroidering».



- > Touch the icon «Start/Stop» and embroider the trim.
  - The embroidery motif must be embroidered already.

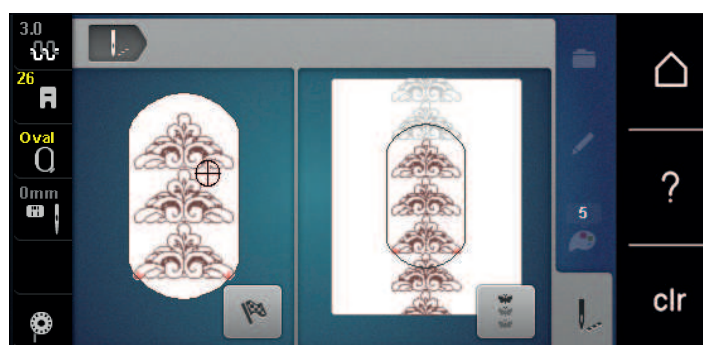



- > Touch the icon «Embroider trims» once the reference points have been embroidered.
  - An animation displays that the fabric has to be re-clamped.

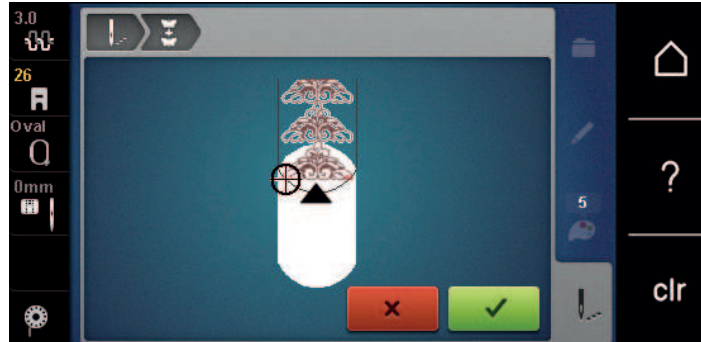

- > Remove the hoop and spin the fabric in such a way that the embroidered reference points are in the upper embroidery field of the hoop and the reference points are located at least 3 cm (1.18 inch) away from the upper edge of the hoop.
- > Attach the hoop.
- > Touch the icon «Confirm».
  - The hoop is automatically moved close to the reference point.
  - The icon «AUTO» is active and the hoop automatically moves close to the last reference point.
- > Use the arrow icons to determine the side of the embroidered section on which you want to position the next reference point.
- > Turn the «Upper multifunction knob» or «Lower multifunction knob» to precisely position the hoop.



- > Touch the icon «Confirm».



- > Press the button «Start/Stop» and continue to embroider.
- > Repeat these steps until the required length of the trim has been achieved.

### Duplicating the embroidery motif

The active embroidery motif is duplicated.

- > Select an embroidery motif.
- > Touch the icon «i»-Dialog.





- > Touch the icon «Duplicate».
- The embroidery motif (1) is duplicated (2).

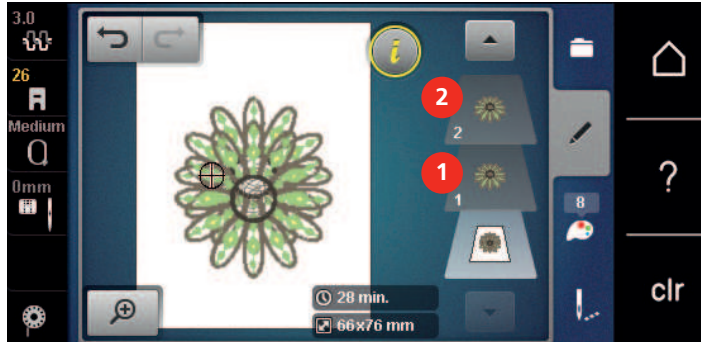

### Deleting an embroidery motif

The active embroidery motif is deleted.

- > Select an embroidery motif.
- > Touch the icon «i»-Dialog.



- > Touch the icon «Delete».

### Changing the sequence within an embroidery motif combination

The sequence of the embroidery motifs within the embroidery motif combination can be changed.

Prerequisite:

- The embroidery motif combination has been created or the motif has been ungrouped.

- > Select the desired embroidery motif which is to be repositioned.
- > Touch the icon «i»-Dialog.



- > Touch the icon «New Allocation».



- > Touch the icon «Scroll up» to position the selected embroidery motif further up within the sequence.



- > Touch the icon «Scroll down» to position the selected embroidery motif further down within the sequence.

### Undoing entries

All entries can be undone and redone again step by step.

Prerequisite:

- An embroidery motif has been selected and alterations have been done.



- > Touch the icon «Undo» to cancel the last entry.
- > Touch the icon «Undo» several times to cancel the last entries step by step.





- > Touch the icon «Redo» to restore the last entry.
- > Touch the icon «Redo» several times to restore the last entries step by step.

## Grouping embroidery motifs

Embroidery motifs can be added to or removed from a group. The grouped embroidery motifs can be processed in the same way as for one embroidery motif.

The sequence of the embroidery motifs in the group can be changed (see page 76).

If the grouping of an embroidery motif has been canceled, i.e. the embroidery motif has been broken down into different elements/colors, the colors are no longer combined for new groupings. With alphabets, the length of the connecting stitches must first be set to 1 in the setup. The cancellation of the group then works for all letters.

- > Create an embroidery motif combination.
- > Select the embroidery motif (1) in the embroidery motif combination.



- > Touch the icon «i»-Dialog.



- > Touch the icon «Grouping».



- > Touch the icon «Grouping».
  - Embroidery motifs above the selected embroidery motif are added to the embroidery motif group.
- > Select the embroidery motif group.



- > Touch the icon «Expand grouping».
  - The grouping is canceled.

or

- > Create an embroidery motif combination.
- > Select all embroidery motifs (2).





> Touch the icon «i»-Dialog.



> Touch the icon «Grouping».  
– All embroidery motifs are added to the embroidery motif group.

> Select the embroidery motif group.

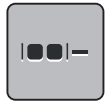

> Touch the icon «Expand grouping».  
– The grouping is canceled.

## 5.6 Pinpoint placement

### Positioning of grid points

This function allows the exact positioning of the embroidery motif on the fabric in an easy way. The positioning points can be placed in the grid.

Prerequisite:

- Any two points of the embroidery motif are marked with chalk or a water-soluble pen on the fabric. The place or the location where the embroidery motif is to be positioned is clearly visible.

> Select an embroidery motif.

> Touch the icon «i»-Dialog.



> Touch the icon «Pinpoint placement».



> Touch the icon «Grid».  
– The embroidery motif is given a grid with nine different location/positioning points.

> Select the desired positioning point to which the embroidery motif is to be adjusted.  
– The point changes its color.

> Turn the «Upper Multifunctional knob» or the «Lower Multifunctional knob» to the left or to the right to position the needle above the respective mark on the fabric.

> Touch the icon «SET» to confirm the altered position.  
– The point changes its color and is defined.



> Select the second positioning point of the embroidery motif.

> Turn the «Upper Multifunctional knob» or the «Lower Multifunctional knob» to the left or to the right to position the needle above the respective mark on the fabric.



> Touch the icon «SET» to confirm the altered position.

– The point changes its color and is defined. The embroidery motif is adjusted accordingly.



- > Touch the icon «Reset Pinpoint placement» to reset the alterations to default setting.

### Free point positioning

This function allows the exact positioning of the embroidery motif on the fabric in an easy way. The points can be defined as you like within the embroidery motif.

Prerequisite:

- Any two points of the embroidery motif are marked with chalk or a water-soluble pen on the fabric. The place or the location where the embroidery motif is to be positioned is clearly visible.

- > Select an embroidery motif.

- > Touch the icon «i»-Dialog.



- > Touch the icon «Pinpoint placement».



- > Touch the icon «Place points as desired».



- > Define a desired point within the embroidery motif.

- The positioning point is displayed.

- > Turn the «Upper Multifunctional knob» or the «Lower Multifunctional knob» to the left or to the right to position the needle above the respective mark on the fabric.

- > Touch the icon «SET» to confirm the altered position.

- The point changes its color and is defined.

- > Select the second positioning point of the embroidery motif.

- > Turn the «Upper Multifunctional knob» or the «Lower Multifunctional knob» to the left or to the right to position the needle above the respective mark on the fabric.



- > Touch the icon «SET» again to confirm the altered position.

- The point changes its color and is defined. The embroidery motif is adjusted accordingly.



- > Touch the icon «Reset Pinpoint placement» to reset the alterations to default setting.

## 5.7 Combining embroidery motifs

### Combining embroidery motifs

In the Combi-Mode several embroidery motifs can be combined.

- > Select an embroidery motif.
- > Touch the icon «Add an embroidery motif» (1).
- > Select another embroidery motif.

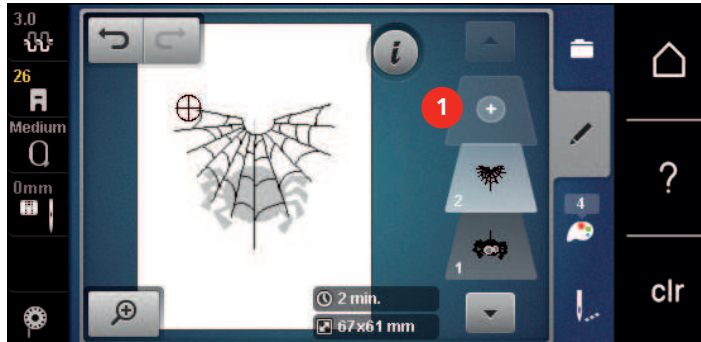

### Deleting a single embroidery motif

Prerequisite:

- A combination of embroidery motifs has been created.
- > In the section of the embroidery motif level (1) touch the desired embroidery motif with the finger, keep it pressed and move it outwards.
  - A new window opens.

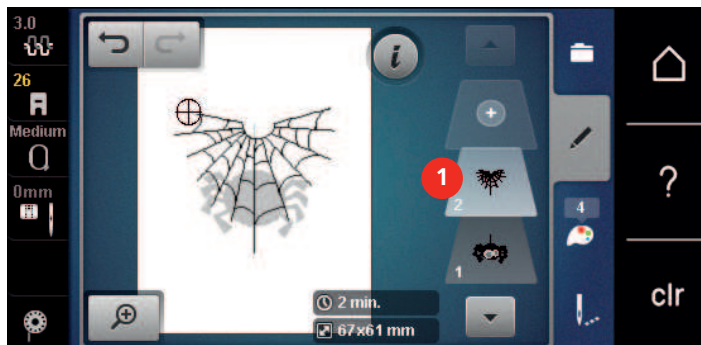

- > Touch the icon «Confirm» to delete the selected embroidery motif.



## Duplicating a combination

When a combination is duplicated, the individual embroidery motifs cannot be selected anymore.

- > Select an embroidery motif.
- > Touch the icon «Add an embroidery motif».
- > Select another embroidery motif.
- > Select the combination (1).



- > Touch the icon «i»-Dialog.



- > Touch the icon «Duplicate».



- The combination is duplicated (2).

## 5.8 Creating lettering

### Overview embroidery alphabets

Embroidery motif	Name
ABC	Swiss Block
<i>ABC</i>	Anniversary
ABC	Guinevere
ABC	Drifter
ABC	Childs Play
АБВ	Russian Textbook
<i>ABC</i>	Curly
ABC	Rounded Sans

### Creating words/sentences



Lettering is always embroidered in one color. To embroider single letters or single words in another color, every letter or every word has to be selected individually and placed in the area to be embroidered.

Lettering can be positioned within the hoop as you like. When the embroidery motif is positioned outside the embroidering area, the hoop is outlined in red on the display. With the hoop selection it can be checked whether or not the embroidery motif can be embroidered in another hoop. When the lettering does not fit in any hoop, two single words can be combined and positioned below each other as the following example will show.



- > Select the file «Alphabets».
- > Select the font.
- > Enter the text «Made to».
- > Touch the icon (1) (standard setting) to use upper case letters.
- > Touch the icon (2) to use lower case letters.
- > Touch the icon (3) to use numbers and mathematic characters.
- > Touch the icon (4) to use special characters.





- > Touch the text box above the keyboard to delete the entered text completely.
- > Touch the icon «DEL» to delete single letters of the entered text.



- > Touch the icon «Confirm» to accept the text.



- > Touch the icon «Embroidery hoop display/Embroidery hoop selection».
- > Select the hoop.
- > Touch the icon «Embroidery hoop display/Embroidery hoop selection» again to go back to the Edit Mode.

### Editing words/sentences



- > Touch the icon «i»-Dialog.

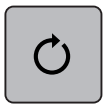

- > Touch the icon «Rotate the motif».



- > Touch the icon «+90» to rotate the text by 90°.
- > Touch the icon «i» (1).

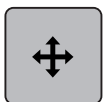

- > Touch the icon «Move the stitch pattern».
- > Turn the «Upper Multifunctional knob» to move the embroidery motif horizontally.
- > Turn the «Lower Multifunctional knob» to move the embroidery motif vertically.



- > Touch the icon «Add motif».
- > Enter and also rotate the text «create».



- > Touch the icon «Embroidery hoop display/Embroidery hoop selection».

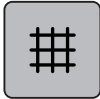

> Touch the icon «Grid on/off» to position the text lines more exactly.

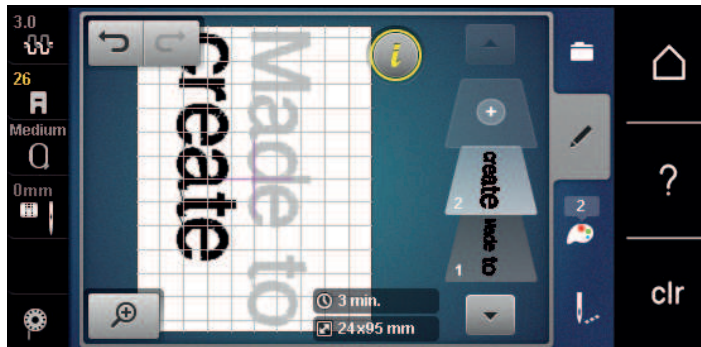

## 5.9 Changing the colors of the embroidery motif

### Overview changing the color

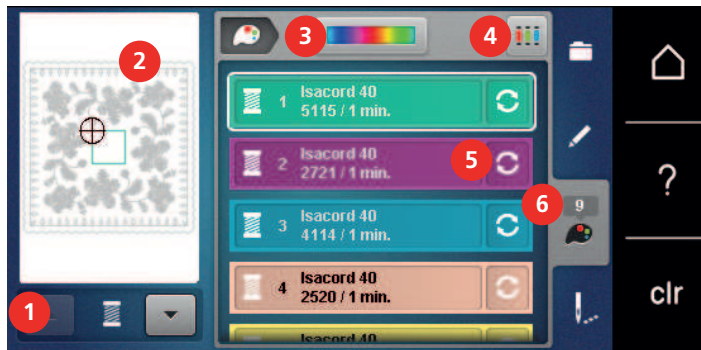

- |   |                             |   |                         |
|---|-----------------------------|---|-------------------------|
| 1 | Colors of embroidery motifs | 4 | Allocating thread brand |
| 2 | Preview for selected color  | 5 | Altering color/brand    |
| 3 | Color wheel                 | 6 | Color information       |

### Changing the colors



- > Select an embroidery motif.
- > Touch the icon «Color information».

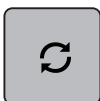

- > Touch the icon «Change color/manufacturer» beside the color that you want to change.
- > To display additional colors, swipe up or down on the display.



- > To select the color by entering the color number, touch the icon «Color selection by number».
- > Enter the number for the required color.
  - The color icon is displayed on the left.
- > To confirm the color selection, touch the color icon that is displayed on the left.



## Altering the colors via the color wheel



- > Touch the icon «Color information».
- > Touch the icon «Color wheel» (1).

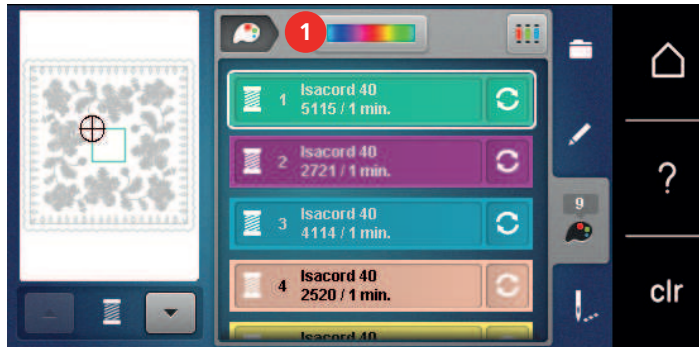

- > Turn the round knob (2) with the the touchscreen pen/finger clockwise or counter-clockwise or turn the «Upper Multifunction knob» to alter the colors of the embroidery motif.



- > Move the slide (3) with the the touchscreen pen/finger to alter the brightness of the colors.



- > Touch the icon «Edit».
  - The embroidery motif appears in the new colors.

### Changing the thread brand



- > Select the embroidery motif.
- > Touch the icon «Color information».

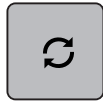

- > Touch the icon «Alter color/brand».



- > To show more thread brands, touch the icons «Scroll left» and «Scroll rights» in the upper part of the screen.



- > Touch the icon «Allocate thread brand».
  - Any thread colors of the selected embroidery motif will be matched with the selected thread brand.

## 5.10 Embroidering the embroidery motif

### Overview Embroidery menu



- |   |  |   |  |
|---|--|---|--|
| 1 | Basting  | 6 | Increasing the embroidery speed (appears by scrolling) |
| 2 | Moving the hoop  | 7 | Reducing color changes (appears by scrolling)          |
| 3 | Embroidery sequence control when thread breaks               | 8 | Endless Embroidery (appears by scrolling)              |
| 4 | Cutting connecting stitches                                  | 9 | Color indication                                       |
| 5 | Multi-colored embroidery motif on/off (appears by scrolling) |   |  |

### Adding basting stitches

The basting stitches can be embroidered along the embroidery hoop or along the embroidery motif. Therefore the connection between the fabric and the stabilizer can be improved.



- > Select an embroidery motif.
- > Touch the icon «Embroidering».



- > Touch the icon «Basting» to embroider basting stitches along the embroidery motif.
- > Touch the icon «Basting» again to embroider basting stitches along the embroidery hoop.
- > Touch the icon «Basting» again to deactivate the basting stitches.

## Moving the hoop

If the embroidery motif is so big that repeated rehooping is necessary, the embroidered motif can be moved again.



- > Select an embroidery motif.
- > Touch the icon «Embroidering».



- > Touch the icon «Move the hoop».
- > Turn the «Upper Multifunctional knob» to move the hoop horizontally.
- > Turn the «Lower Multifunctional knob» to move the hoop vertically.



- > Touch the icon «Embroidering» in the process navigation to accept the settings.

## Embroidery sequence control when thread breaks

When the thread breaks, the needle can be repositioned in the embroidery motif by means of the embroidery sequence control.



- > Select an embroidery motif.
- > Touch the icon «Embroidering».



- > Touch the icon «Embroidery sequence control when thread breaks».
  - In the left portion of the display a compact view of the embroidery motif is displayed. On the right side the enlarged embroidery motif is displayed.
- > Select the desired position in the compact view using the touchscreen pen/finger.
- > Turn the «Upper Multifunctional knob» to move the hoop stitch by stitch.
- > Turn the «Lower Multifunctional knob» to move the hoop in large steps.
  - The number in the yellow-framed icon indicates the number of stitches within the embroidery sequence.



- > Touch the icon «Magnifier» to select the desired stitch via entry.

## Cutting connecting stitches

The function is activated by default and the connecting stitches are cut automatically. When the function is deactivated, the connecting stitches between the embroidery motifs must be cut manually.



- > Select an embroidery motif.
- > Touch the icon «Embroidering».



- > Touch the yellow-framed icon «Cut the connecting stitches» to deactivate the function.
- > Touch the yellow-framed icon «Cut the connecting stitches» again to activate the function.

## Reducing color changes

When the embroidery motifs overlap, the color changes **cannot** be reduced.

- > Select an embroidery motif.



> Touch the icon «Embroidering».



> Touch the icon «Reduce thread change».  
 – Identical colors of the embroidery motif are collected to one color.

### Multi-colored embroidery motif on/off

Multi-colored embroidery motifs can also be embroidered in one color.



> Select an embroidery motif.  
 > Touch the icon «Embroidering».



> Touch the icon «Multi-colored embroidery motif on/off».  
 – The embroidery motif is embroidered in one color.

### Endless Embroidery

This makes it possible to embroider trims that have already been started, even if the machine has been switched off and on.

Prerequisite:

- A trim embroidery motif must be saved on a separate storage medium. The reference points must be included in the embroidery motif.



> Select trim embroidery motifs from the separate storage medium.  
 > Touch the icon «Embroidering».



> The icon «Embroider trims» becomes visible if you scroll upwards in the right-hand toolbar.  
 > Touch the icon «Embroider trims».

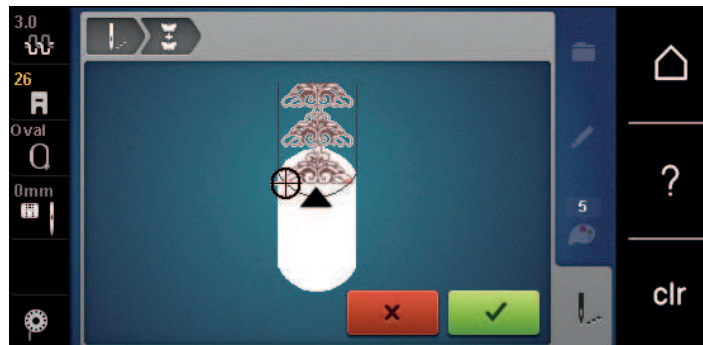

> Remove the hoop and spin the fabric in such a way that the embroidered reference points are in the upper embroidery field of the hoop and the reference points are located at least 3 cm (1.18 inch) away from the upper edge of the hoop.

> Attach the hoop.





> Touch the icon «Confirm».  
 – The hoop is automatically moved close to the last stitch.  
 – The icon «AUTO» is active and the hoop automatically moves close to the last reference point.

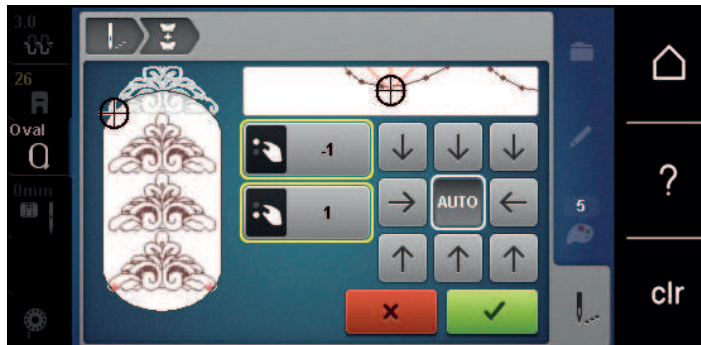

- > Use the arrow icons to determine the side of the embroidered section on which you want to position the next reference point.
- > Turn the «Upper multifunction knob» or «Lower multifunction knob» to precisely position the hoop.





-  > Touch the icon «Confirm».
-  > Press the button «Start/Stop» and continue to embroider.
- > Repeat these steps until the required length of the trim has been achieved.

### Color indication

Every color of the embroidery motif can be selected individually. The hoop moves to the first stitch of the current color. The currently active color can be embroidered individually or in another sequence.

- > Select an embroidery motif.
- > Touch the icon «Embroidering».



-  > Touch the icon «Scroll down» to select the next color of the embroidery motif.
-  > Touch the icon «Scroll up» to select the previous color of the embroidery motif.

## 5.11 Free arm embroidering

Free arm embroidering is defined as embroidering tubular fabrics or garments which are positioned around the free arm of the embroidery machine while being embroidered. Often used with sleeves, pant legs or other narrow-tailored garments.



A tubular piece of fabric can be pulled over the free arm of the machine easily when the free arm is positioned to the left in parking position before the hoop is attached or removed. Push the button «Start/Stop» to move the embroidery hoop back to the embroidery position again.

Make sure to use a full bobbin as the embroidery hoop needs to be removed for changing the bobbin.

Borders can be closed to a ring easily and exactly along the edge of the tube. Before embroidering the last embroidery motif, after rehooping the fabric, activate the function «Pinpoint placement» in the edit mode. Using the subfunction «Free point positioning» align the still missing embroidery motif precisely.

The movability of the embroidery arm can be limited or impeded with very narrow tubes. Therefore please make sure that the embroidery hoop can move forwards and backwards sufficiently. An impediment of the embroidery arm caused by a tube which is too tight can result in embroidery motif offset or in damaging the fabric.

### Check the movability of the free arm

Please note: With tiny fabric tubes, deactivate the thread-away in the Setup Program if necessary.

- > Open the embroidery motif on the machine and edit as desired.

- > Mark the embroidery motif position and the size on the fabric in a suitable way.
- > Select the embroidery hoop as small as possible.
- > Hoop or stick the fabric along with the appropriate stabilizer in the embroidery hoop, depending on the stabilizer.
- > Pull the fabric tube carefully over the free arm of the machine and attach the embroidery hoop at the clutch of the embroidery module.
- > If necessary, reposition the embroidery motif.
- > Previously check whether the embroidery hoop can be moved forwards and backwards according to the embroidery motif size.

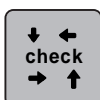

- > Touch the icon «Check embroidery motif size».
- > After the successful check of the embroidery motif size, start the embroidery process.

Detailed instructions about embroidery, the use of suitable materials or selecting the required embroidery settings of the machine can be found in the «Tutorial» under embroidery techniques --> Embroidering.

## 5.12 Administering embroidery motifs

### Administering embroidery motifs

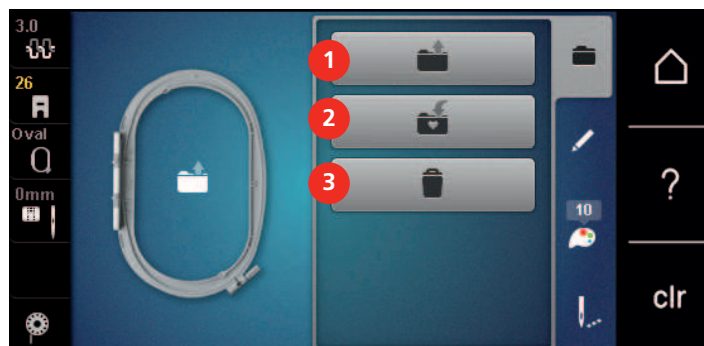

- |   |                              |   |          |
|---|------------------------------|---|----------|
| 1 | Loading the embroidery motif | 3 | Deleting |
| 2 | Saving the embroidery motif  |   |          |

### Saving embroidery motifs in the personal memory

In the filing system «Personal memory» any stitch patterns, also those which have been individually edited, can be saved.

- > Select an embroidery motif.
- > Edit the embroidery motif.
- > Touch the icon «Selection».



- > Touch the icon «Save the motif».
  - The embroidery motif to be saved is outlined in yellow.
  - The icon «Embroidery machine» is activated.



- > Touch the icon «Confirm».



### Saving the embroidery motif on the BERNINA USB stick

- > Select an embroidery motif.
- > Edit the embroidery motif.
- > Touch the icon «Selection».

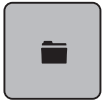

- > Touch the icon «Save the motif».
  - The embroidery motif to be saved is outlined in yellow.



- > Insert the BERNINA USB stick into the USB port of the machine.



- > Touch the icon «USB stick».



- > Touch the icon «Confirm».

### Overwriting the embroidery motif in the personal memory

- > Select an embroidery motif.
- > Edit the embroidery motif.
- > Touch the icon «Selection».



- > Touch the icon «Save the motif».
  - The embroidery motif to be saved is outlined in yellow.



- Touch the icon «Embroidery machine» is activated.



- > Select the embroidery motif which is to be overwritten.



- > Touch the icon «Confirm».

### Overwriting the embroidery motif on the BERNINA USB stick

- > Select an embroidery motif.
- > Edit the embroidery motif.
- > Touch the icon «Selection».



- > Touch the icon «Save the motif».
  - The embroidery motif to be saved is outlined in yellow.



- > Insert the BERNINA USB stick into the USB port of the machine.



- > Touch the icon «USB stick».

- > Select the embroidery motif which is to be overwritten.



- > Touch the icon «Confirm».

### Loading an embroidery motif from the personal memory



> Touch the icon «Selection».



> Touch the icon «Upload embroidery motif».



> Select the file «Personal embroidery motifs».  
> Select an embroidery motif.

### Loading an embroidery motif from the BERNINA USB stick



> Touch the icon «Selection».  
> Insert the BERNINA USB stick into the USB port of the machine.



> Touch the icon «USB stick».  
> Select a personal embroidery motif.

### Deleting an embroidery motif from the personal memory

The embroidery motifs which are saved in the personal memory can be deleted individually.



> Touch the icon «i»-Dialog.



> Touch the icon «Delete».



– Touch the icon «Embroidery machine» is activated.



> Select the embroidery motif which is to be deleted.  
> Touch the icon «Confirm».

### Deleting an embroidery motif from the BERNINA USB stick



> Touch the icon «Selection».



> Touch the icon «Delete».  
> Insert the BERNINA USB stick into the USB port of the machine.



> Touch the icon «USB stick».  
> Select the embroidery motif which is to be deleted.



> Touch the icon «Confirm».



## 6 Embroidery

### 6.1 Embroidering via the button «Start/Stop»

In case of a power cut the embroidery process is interrupted. After the restart the machine goes to the position which was embroidered last.



- > Push the button «Start/Stop» to start the embroidery machine.
  - All parts of the motif being in the current color are embroidered.
  - The embroidery machine stops automatically at the end.
  - Both threads are cut automatically.
  - The embroidery machine switches to the next color automatically.



- > Change the upper thread.
- > Push the button «Start/Stop» to embroider the new color.
- > After completing the embroidery motif, finish the embroidering process by touching the icon «Finishing the embroidering process» (1) or embroider the motif again by touching the icon «Endless embroidery»(2).

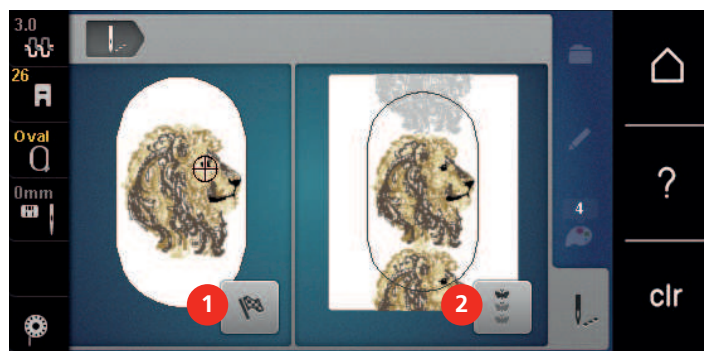

### 6.2 Increasing the embroidery speed

To ensure the best embroidery quality, the speed when embroidering is reduced depending on the embroidery position. Choose between the two options to either embroider at optimal or maximum speed. Standard = optimal speed. It has to be considered that the quality of the embroidered embroidery motif at maximum speed cannot be ensured.

By switching the machine off and on, the optimal embroidery speed is activated.

Prerequisite:

- The embroidery motif is selected.



- > Touch the icon «Embroidery speed».
  - The maximum speed is activated.
- > Touch the icon «Embroidery speed» again.
  - The optimal speed is activated.

### 6.3 Adjusting the upper thread tension

The default setting of the upper thread tension is applied automatically when an embroidery motif is selected.

The upper thread tension is set optimally at the BERNINA factory and the machine has been tested. Metrosene-/Seralon thread size 100/2 (Company Mettler, Switzerland) is used for upper and bobbin thread.

When using other types of embroidery threads, the optimal tension may vary. Therefore it may be necessary to adjust the upper thread tension according to the embroidery project as well as the desired embroidery motif individually.

The higher the upper thread tension, the tighter the upper thread which means that the bobbin thread is pulled up to the top of the fabric. When the upper thread tension is low, the upper thread is less tightened which means that the bobbin thread is pulled up less.

Alteration of the upper thread tension affect all embroidery motifs. Permanent alterations of the upper thread tension can be made in the Setup Program (see page 50).



- > Touch the icon «Upper thread tension».
- > Move the slide with the touchscreen pen or the finger to increase or reduce the upper thread tension.



- > Touch the yellow-framed icon on the right side to reset the alteration to default setting.
- > If the upper thread tension had been changed in the Setup Program, touch the yellow-framed icon on the left to reset the alterations to default setting in the **Setup Program**.

## 6.4 Embroidering via the foot control (Optional accessory)

Embroidering via the foot control is recommended when only a short sequence has to be embroidered. While embroidering, the foot control must be pressed down all the time.

- > Press the foot control to start embroidering.

## 7 Appendix

### 7.1 Maintenance and cleaning

#### Cleaning the display

- > Clean the display in the switched off status with a soft slightly damp microfiber cloth.

#### Removing thread remnants under the stitch plate



##### Electronically driven components

Risk of injury near the needle and the hook.

- > Switch the machine off and disconnect it from the power supply system.

Remove the thread remnants under the stitch plate regularly.

- > Remove the presser foot and the needle.
- > Remove the stitch plate.



- > Remove the thread remnants under the stitch plate.

#### Cleaning the hook



##### Electronically driven components

Risk of injury near the needle and the hook.

- > Switch the machine off and disconnect it from the power supply system.

- > Open the bobbin cover.
- > Remove the bobbin case.
- > Push the fastening bracket to the left.

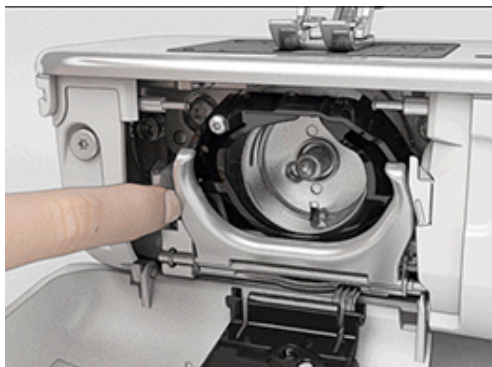

- > Flap down the fastening bracket along with the black hook race cover.

- > Remove the hook.

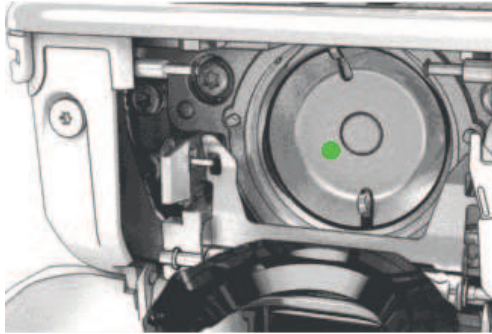

- > Clean the hook race area with the brush; never use a sharp instrument.
- > Hold the hook at the pin in the center with two fingers.
- > Lead the hook, lower edge ahead, angular top-down behind the hook race cover.
- > Position the hook with the two lugs meeting the openings in the hook, the colored mark on the hook driver should be visible through the hole in the hook.
- > Insert the hook.
  - The hook is magnetic and therefore fastened to the correct position.
- > Close the hook race cover and the fastening bracket until the release bracket engages.
- > As a check, turn the handwheel.
- > Insert the bobbin case.

### Lubricating the hook



CAUTION

#### Electronically driven components

Risk of injury near the needle and the hook.

- > Switch the machine off and disconnect it from the power supply system.

NOTICE

#### Lubricating the hook

Too much oil can pollute the fabric and the thread.

- > After lubricating, sew/embroider a test piece first.

- > Remove the bobbin case.
- > Push the fastening bracket to the left.

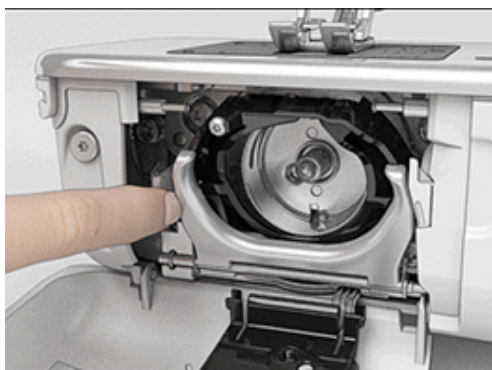

- > Flap down the fastening bracket along with the black hook race cover.



- > Remove the hook.

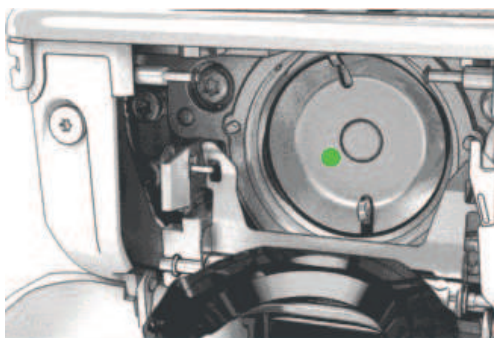

- > Give one drop of BERNINA oil down in the hook race.

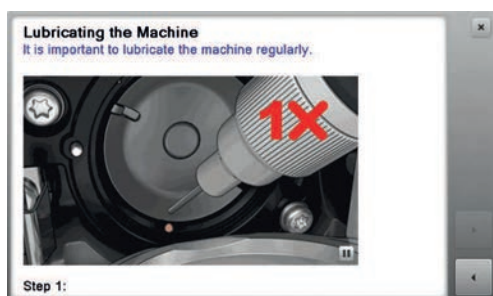



- > Give one drop of oil in each of the two oil depots so that the felts are damp and make sure that the red-marked surface of the hook sleeve remains free of oil.



- > Hold the hook at the pin in the center with two fingers.
- > Lead the hook, lower edge ahead, angular top-down behind the hook race cover.
- > Position the hook with the two lugs meeting the openings in the hook, the colored mark on the hook driver should be visible through the hole in the hook.
- > Insert the hook.
  - The hook is magnetic and therefore fastened to the correct position.
- > Close the hook race cover and the fastening bracket until the release bracket engages.
- > As a check, turn the handwheel.
- > Insert the bobbin case.





## 7.2 Troubleshooting



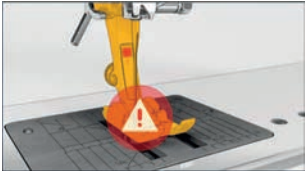

Fault	Cause	Repair
<b>Uneven stitch formation</b>	Upper thread too tight or too loose.	> Adjust upper thread tension.
	Needle blunt or bent.	> Replace the needle, make sure that a new BERNINA quality needle is used.
	Poor quality needle.	> Use a new BERNINA quality needle.
	Poor quality thread.	> Use quality thread.
	Incorrect needle/thread combination.	> Match the needle with the thread size.
	Incorrectly threaded.	> Rethread.
<b>Uneven stitch formation</b>	Incorrect bobbin case is used.	> Use the supplied bobbin case marked with the triangle.
		
<b>Skipped stitches</b>	Incorrect needle.	> Use the needle system 130/705H.
	Needle blunt or bent.	> Replace the needle.
	Poor quality needle.	> Use a new BERNINA quality needle.
	The needle is incorrectly inserted.	> Insert the needle with the flat side to the back as far up as it will go into the needle holder and tighten the screw.
	Incorrect needle point.	> Match the needle point to the texture of the material.
<b>Uneven stitching</b>	Thread remnants between the thread tension discs.	> Fold a piece of thin material and slide the folded edge (not the raw edges) between the thread tension discs.
	Incorrectly threaded.	> Rethread.
	Thread remnants below the bobbin case spring.	> Remove the thread remnants under the spring.

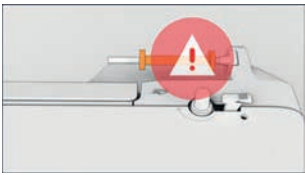



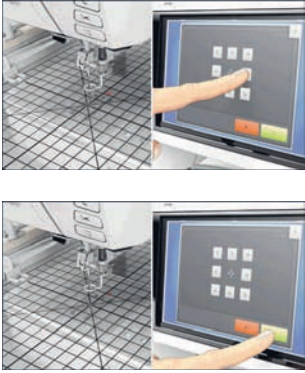

Fault	Cause	Repair
<b>Upper thread breaks</b>	Incorrect needle/thread combination.	> Match the needle with the thread size.
	Upper thread is too tight.	> Reduce the upper thread tension.
	Incorrectly threaded.	> Rethread.
	Poor quality thread.	> Use quality thread.
	The stitch plate or the hook tip is damaged.	> Contact the nearest specialized BERNINA dealer to have the damages repaired. > Replace the stitch plate.
	The thread is caught in the area of the thread take-up lever. 	> Slide the headframe (1) to the left, then remove it. > Remove the thread remnants. > Insert the 4 knobs of the headframe into the provided notches and slide the headframe to the right.
<b>Lower thread breaks</b>	The bobbin case is damaged.	> Replace the bobbin case.
	The stitch hole in the stitch plate is damaged.	> Contact the nearest specialized BERNINA dealer to have the damages repaired. > Replace the stitch plate.
	Needle blunt or bent.	> Replace the needle.
<b>Needle breaks</b>	The needle is incorrectly inserted.	> Insert the needle with the flat side to the back as far up as it will go into the needle holder and tighten the screw.
	Knotted thread.	> Use quality thread.
<b>Speed too low</b>	Unfavorable room temperature.	> Place the machine in a warm room one hour before use.
	Settings in the Setup Program.	> Adjust the sewing speed in the Setup Program. > Adjust the slide.
<b>The machine doesn't start</b>	Unfavorable room temperature.	> Place the machine in a warm room one hour before use. > Connect the machine and switch it on.
	The machine is damaged.	> Contact the specialized BERNINA dealer.
<b>Neither the sewing light nor the light on the free arm lights up</b>	Settings in the Setup Program.	> Activate it in the Setup Program.
	The sewing light is defect.	> Contact the specialized BERNINA dealer.

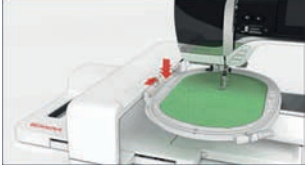
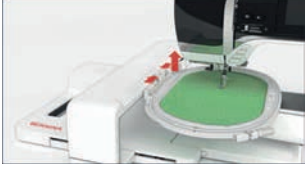

Fault	Cause	Repair
<b>Upper thread indicator doesn't react</b>	Settings in the Setup Program.	> Activate it in the Setup Program.
	The upper thread indicator is defect.	> Contact the specialized BERNINA dealer.
<b>Bobbin thread indicator doesn't react</b>	Settings in the Setup Program.	> Activate it in the Setup Program.
	The bobbin thread indicator is defect.	> Contact the specialized BERNINA dealer.
<b>Error during software update</b>	USB stick is not recognized.	> Use a BERNINA USB stick.
	The update process is blocked and the hourglass on the display is inactive.	> Remove the USB stick. > Switch the machine off. > Switch the machine on. > Follow the instruction on the display.
	Date of the software update cannot be found.	> Unzip the update data. > Save data of the software update directly on the data medium and not in a file on the USB stick.

### 7.3 Error messages

Message on the display	Cause	Solution
	The selected needle and stitch plate cannot be used in combination.	> Replace the needle. > Replace the stitch plate.
	The needle is not at its top end.	> Adjust the needle position via the handwheel.
	The upper thread is used up.	> Rethread.
	The upper thread has broken.	> Rethread.
	The bobbin thread is used up.	> Rethread.
	The bobbin thread has broken.	> Clean the hook. > Rethread.

Message on the display	Cause	Solution
	The main motor isn't running.	<ul style="list-style-type: none"> <li>&gt; Turn the handwheel clockwise until the needle is at its top position.</li> <li>&gt; Remove the stitch plate.</li> <li>&gt; Remove the thread remnants.</li> <li>&gt; Clean the hook.</li> <li>&gt; Remove the hook and make sure that there are no pieces of broken needle points on the magnetic back of the hook.</li> </ul>
	The contact between the machine and the embroidery module is interrupted due to vibrations.	<ul style="list-style-type: none"> <li>&gt; Make sure that the module and the machine are standing on a stable, even surface.</li> <li>&gt; Connect the embroidery module to the machine.</li> </ul>
	The needle position doesn't correspond with the center of the hoop.	<ul style="list-style-type: none"> <li>&gt; Calibrate the hoop.</li> </ul>
	The embroidery module is not attached.	<ul style="list-style-type: none"> <li>&gt; Connect the embroidery module to the machine.</li> <li>&gt; Contact the specialized BERNINA dealer to have the machine checked.</li> </ul>
	The hoop is not attached.	<ul style="list-style-type: none"> <li>&gt; Attach the hoop.</li> </ul>
	The hoop is attached.	<ul style="list-style-type: none"> <li>&gt; Remove the embroidery hoop.</li> </ul>

Message on the display	Cause	Solution
	The movement of the hoop follows.	> Touch the icon «Confirm».
	Mega Hoop top.	> Bring the Mega Hoop to the top position.
	Mega Hoop center.	> Bring the Mega Hoop to the center position.
	Mega Hoop bottom.	> Bring the Mega Hoop to the lower position.
	The embroidery motif is partly outside the hoop.	> Reposition the embroidery motif and start embroidering it again.
	The embroidery motif is too large.	> Reduce the size of the embroidery motif. > Attach a larger embroidery hoop.
Not enough free capacity on the BERNINA USB stick (optional accessory).	Not enough free capacity on the BERNINA USB stick (optional accessory).	> Make sure that the BERNINA USB stick (optional accessory) is used. > Delete data from the BERNINA USB stick (optional accessory).

Message on the display	Cause	Solution
No personal data on the BERNINA USB stick (optional accessory).	No personal data for recovery available on the BERNINA USB stick (optional accessory).	> Make sure that the data and settings have been saved on the BERNINA USB stick (optional accessory).
The recovery of personal data has failed.	The software update has been successful but the personal data couldn't be recovered.	> Make sure that the data and settings have been saved on the BERNINA USB stick (optional accessory). > Transfer saved data to the machine.
No BERNINA USB stick is inserted. Make sure that during the complete automatic update always the same BERNINA USB stick remains inserted.	The BERNINA USB stick (optional accessory) is not inserted.	> Use a BERNINA USB stick (optional accessory) providing enough free capacity.
The update of the software has failed.	The latest software version cannot be found on the USB stick.	> Make sure that the compressed zip file has been unzipped for the software update. > Check whether the data for the software update are saved directly on the data medium and not in a file on the USB stick. > Update the software.
 	The machine needs cleaning/ lubricating.	> Clean the machine. > Lubricate the hook.  <b>Important information on lubricating:</b>  Too much oil can pollute the fabric and the thread. > After lubricating, sew/embroider a test piece first.
The automatic thread cutter (at the thread catcher) needs cleaning.	The automatic thread cutter needs cleaning. The message appears every time when the machine is started as soon as 1000 cutting cycles have been carried out.	> Touch the icon «Confirm». <ul style="list-style-type: none"> <li>– The machine calls up the function «Clean the thread catcher».</li> </ul> > Clean the thread catcher according to the instructions on the display. <ul style="list-style-type: none"> <li>– The counter for the cutting cycles is reset.</li> </ul>

Message on the display	Cause	Solution
It is time for the regular maintenance. Please contact your specialized BERNINA dealer to make an appointment.	<p>The machine needs maintenance. The message appears after the programmed service interval has expired.</p> <p><b>Important information:</b> Having your machine cleaned and serviced properly at the appropriate times ensures its proper functioning and a long service life. Ignoring the terms can affect the operating life and restrict the guaranteeing. The cost allocation for maintenance work is regulated nationally. Consult your specialised dealer or your servicing shop for more details.</p>	<ul style="list-style-type: none"> <li>&gt; Contact the specialized BERNINA dealer.</li> <li>&gt; Delete the message temporarily by touching the icon «ESC».</li> </ul> <p>Having cleared the message three times, the message will appear as recently as the next service interval has been completed.</p>

## 7.4 Storage and disposal

### Storing the machine

It is recommended to store the machine in the original packaging. If the machine is stored in a cold room, place it in a warm room one hour before use.

- > Switch the machine off and disconnect it from the power supply system.
- > Don't store the machine outdoor.
- > Protect the machine against climatic influences.

### Dispose of the machine

- > Clean the machine.
- > Sort the components by their materials and dispose of them according to the local laws and regulations.



## 7.5 Technical data

Designation	Value	Unit
Maximum fabric thickness	10.5 (0.41)	mm (in)
Sewing light	12 bis 16	LED
Maximum speed	1000	Stitches per minute
Measurements without the spool pin (W × H × D)	465 × 330 × 200 (18.30 × 12.99 × 7.87)	mm (in)
Weight	9.6 (21.16)	kg (lb)
Energy consumption	90	W
Input voltage	100 – 240	V
Protection class (Electrical engineering)	II	

## 8 Overview stitch patterns













### 8.1 Overview Embroidery motifs

#### Editing embroidery motifs

Let your creativity run free. A vast selection of embroidery motifs is at your disposal.





If one of the following pictograms is under the embroidery motif number, you can find additional information at

[www.bernina.com/specialeffects](http://www.bernina.com/specialeffects).

	Detached point		Punchwork Design (motif)
	Hole embroidery		Cord embroidery
	Fringe embroidery		Projects in the hoop
	Appliqué		Puffy fonts
	CutWork Design (motif)		Quilting
	PaintWork Design (motif)		Trapunto
	CrystalWork Design (motif)		

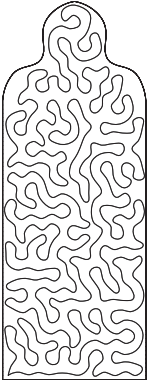

#### Projects



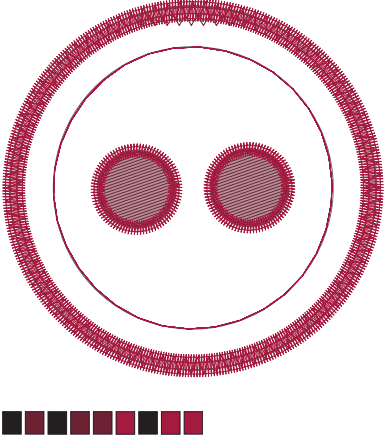



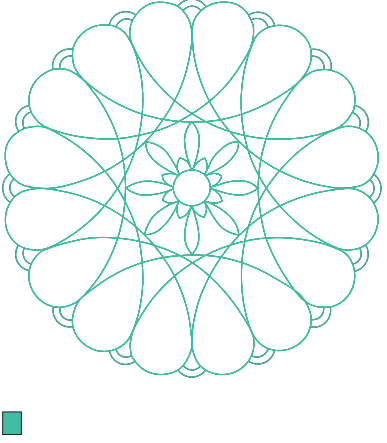



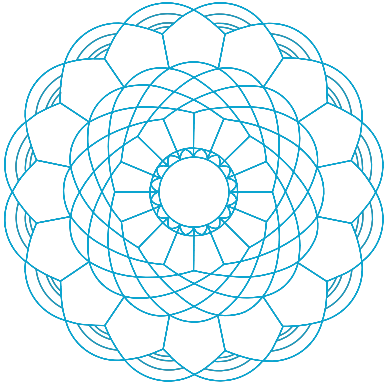

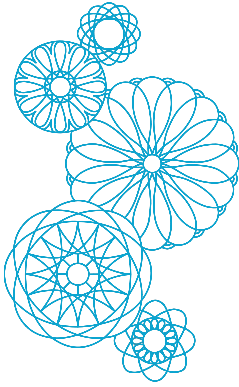

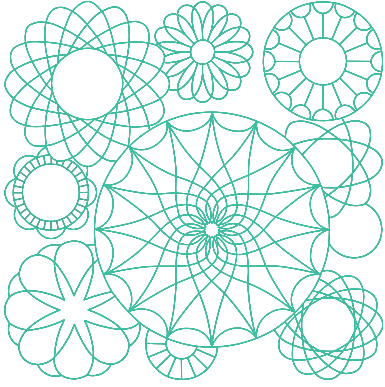
You can find the detailed stitch instructions at [www.bernina.com/500designs](http://www.bernina.com/500designs)

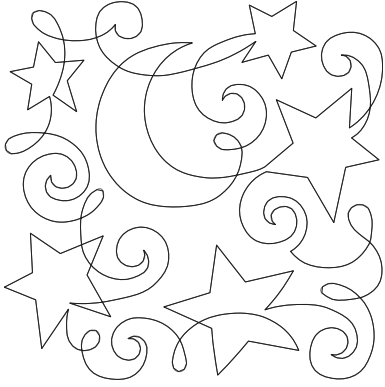





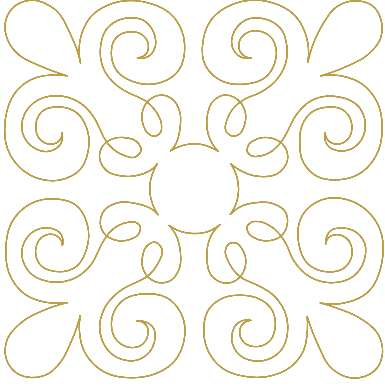



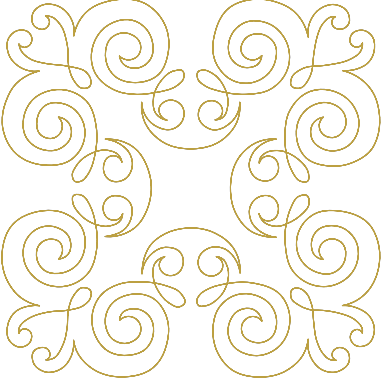

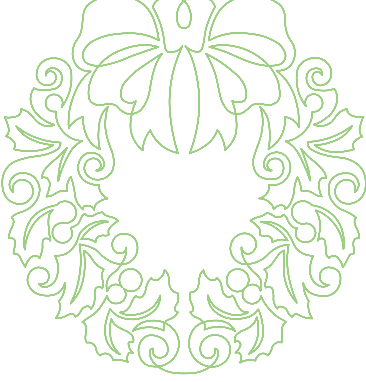

No.	Embroidery motif	No.	Embroidery motif
Width x Height	Colors	Width x Height	Colors
> mm		> mm	
> inch		> inch	
12593-04  95.3 x 174.0 3.75 x 6.85	 	12536-03  112.9 x 226.1 4.44 x 8.90	 

No.	Embroidery motif	No.	Embroidery motif
Width x Height	Colors	Width x Height	Colors
> mm		> mm	
> inch		> inch	
12619-04 0 57.8 x 57.4 2.27 x 2.25			

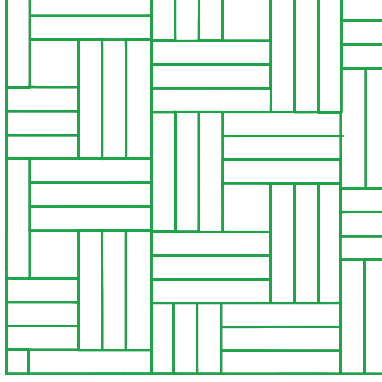

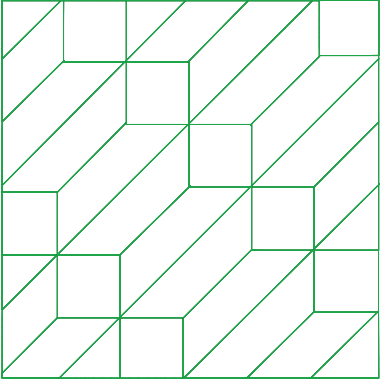

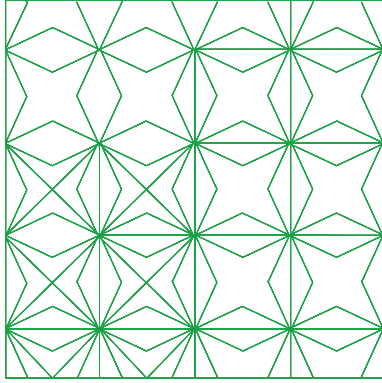





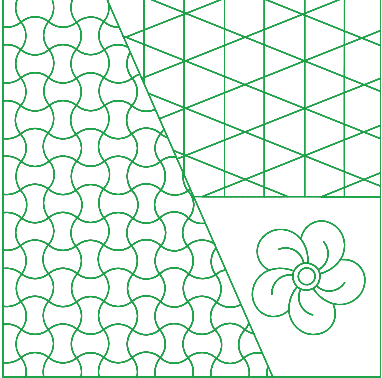

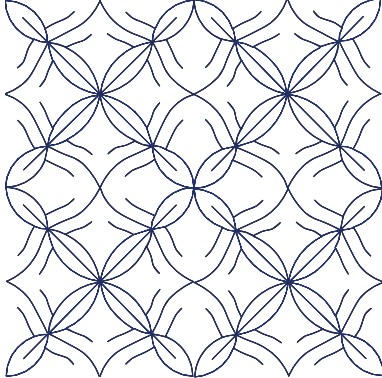
**Quilt motifs**

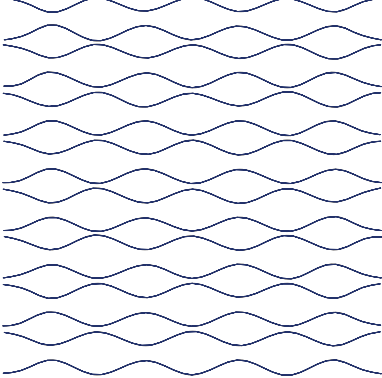

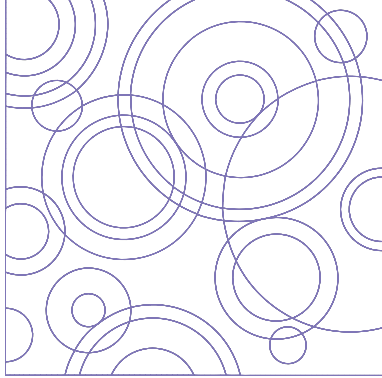

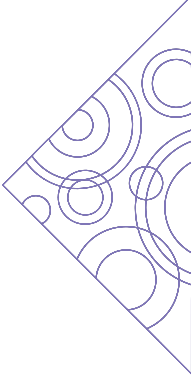

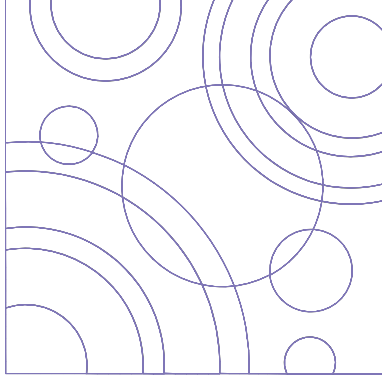



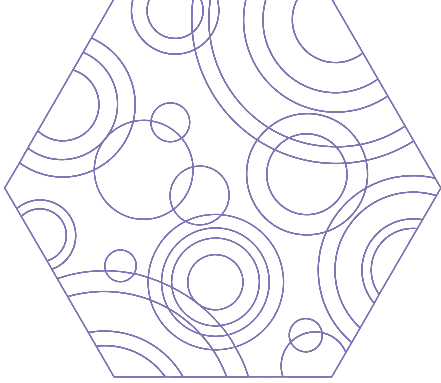

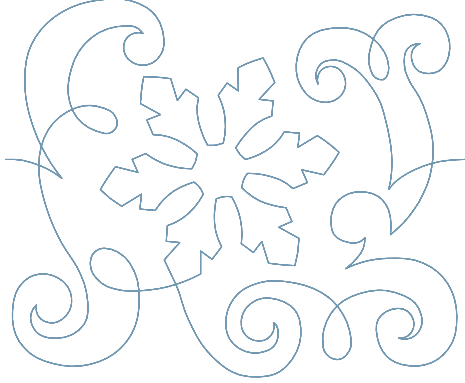

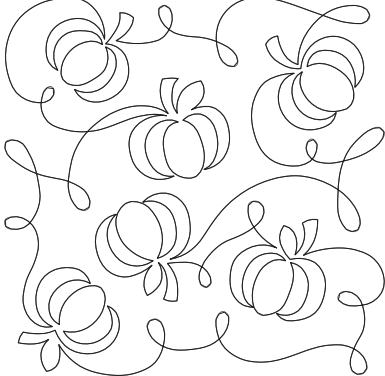
No.	Embroidery motif	No.	Embroidery motif
Width x Height	Colors	Width x Height	Colors
> mm		> mm	
> inch		> inch	
12499-06 101.7 x 101.6 4.00 x 4.00		12499-04 123.2 x 123.0 4.85 x 4.84	

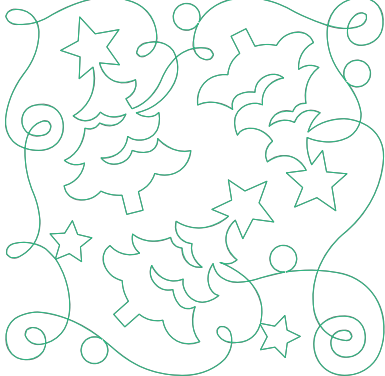
No. Width x Height > mm > inch	Embroidery motif Colors	No. Width x Height > mm > inch	Embroidery motif Colors
12499-05  123.3 x 123.3 4.85 x 4.85	 	12499-24  133.1 x 214.7 5.24 x 8.45	 
12499-23  123.3 x 123.3 4.85 x 4.85	 	12607-20  122.4 x 122.3 4.81 x 4.81	 
12607-21  61.2 x 122.7 2.40 x 4.83	 	12416-04  89.2 x 89.1 3.51 x 3.50	 





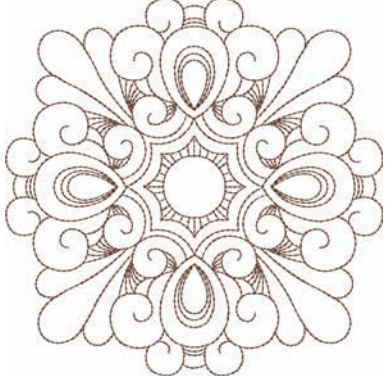





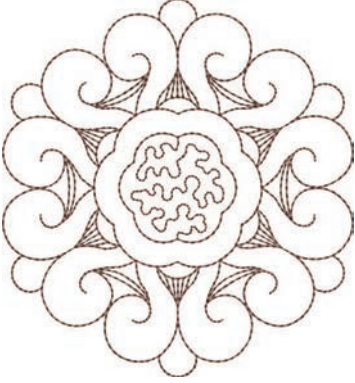





No. Width x Height > mm > inch	Embroidery motif Colors	No. Width x Height > mm > inch	Embroidery motif Colors
12416-03  124.0 x 124.0 4.88 x 4.88	 	12416-26  43.7 x 174.1 1.72 x 6.85	 
12416-48  160.0 x 167.0 6.30 x 6.60	 	NB346-48  76.2 x 76.3 3.00 x 3.00	 
NB347-48  76.2 x 76.3 3.00 x 3.00	 	NB334-48  127.0 x 127.0 5.00 x 5.00	 

Overview stitch patterns



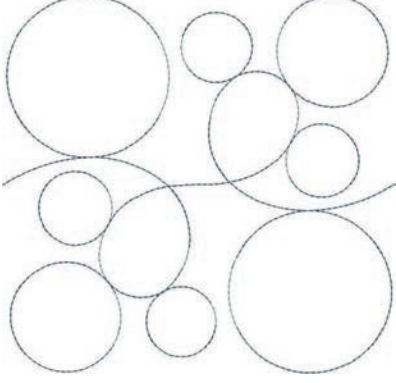

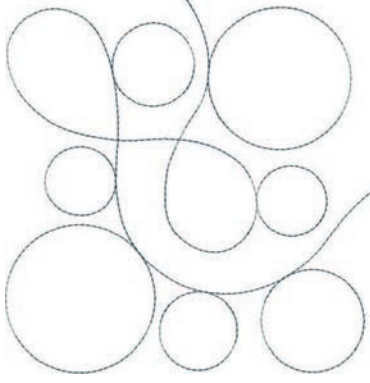





No. Width x Height > mm > inch	Embroidery motif Colors	No. Width x Height > mm > inch	Embroidery motif Colors
NB335-48  127.1 x 127.1 5.00 x 5.00	 	NZ498  88.9 x 88.9 3.50 x 3.50	 
NZ503  99.1 x 98.7 3.90 x 3.88	 	82013-29  121.2 x 121.2 4.76 x 4.76	 
82013-30  83.0 x 166.1 3.26 x 6.53	 	82013-31  57.6 x 57.6 2.26 x 2.26	 

No. Width x Height > mm > inch	Embroidery motif Colors	No. Width x Height > mm > inch	Embroidery motif Colors
82013-32  121.8 x 105.6 4.79 x 4.15	 	12416-24  88.9 x 73.1 3.50 x 2.87	 
 12607-16 122.8 x 122.3 4.83 x 4.81	 	12616-16  122.8 x 122.6 4.83 x 4.82	 
12380-22  110.6 x 60.9 4.35 x 2.39	 	12380-43  123.5 x 123.5 4.86 x 4.86	 





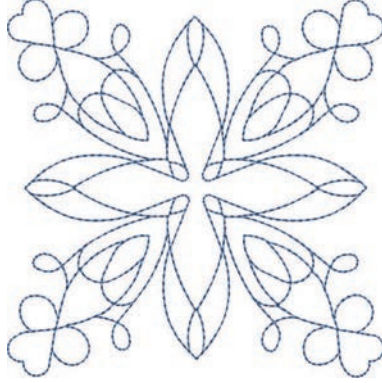





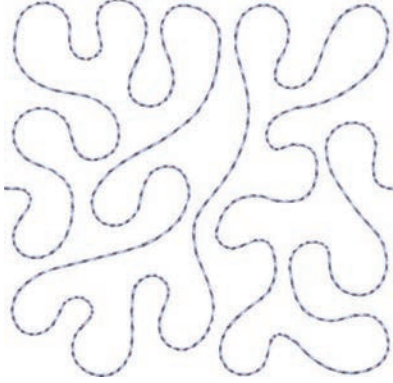

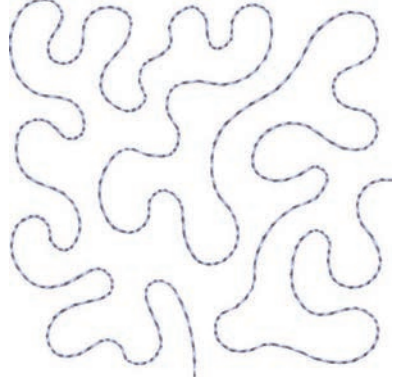



Overview stitch patterns



No. Width x Height > mm > inch	Embroidery motif Colors	No. Width x Height > mm > inch	Embroidery motif Colors
12380-30  89.2 x 96.3 3.51 x 3.79	 	12380-04  83.1 x 89.9 3.27 x 3.53	 
12380-08  89.2 x 89.1 3.51 x 3.50	 	12380-09  111.6 x 61.6 4.39 x 2.42	 
BD800  127.3 x 122.4 5.01 x 4.81	 	BD801  122.2 x 124.2 4.81 x 4.88	 





No. Width x Height > mm > inch	Embroidery motif Colors	No. Width x Height > mm > inch	Embroidery motif Colors
BD804  122.9 x 123.6 4.83 x 4.86	 	BD796  47.2 x 174.5 1.85 x 6.87	 
BD837  123.6 x 123.6 4.86 x 4.86	 	BD292  94.8 x 95.1 3.73 x 3.74	 
BD299  94.5 x 95.0 3.72 x 3.74	 	BD308  95.0 x 94.4 3.74 x 3.71	 















No. Width x Height > mm > inch	Embroidery motif Colors	No. Width x Height > mm > inch	Embroidery motif Colors
BD413  97.1 x 97.2 3.82 x 3.82	 	BD554  109.9 x 109.9 4.32 x 4.32	 
BD553  113.8 x 121.1 4.48 x 4.76	 	BD567  107.9 x 108.2 4.24 x 4.25	 
BD394  97.0 x 96.8 3.81 x 3.81	 	BD412  89.4 x 53.2 3.51 x 2.09	 

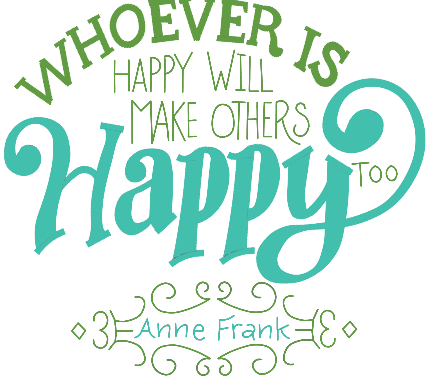

No. Width x Height > mm > inch	Embroidery motif Colors	No. Width x Height > mm > inch	Embroidery motif Colors
BD501  63.5 x 61.1 2.50 x 2.40	 	BD502  61.5 x 60.7 2.42 x 2.38	 
BD513  63.5 x 63.4 2.50 x 2.49	 	BD514  63.5 x 62.9 2.50 x 2.47	 
BD562  63.9 x 126.0 2.51 x 4.96	 	BD568  109.5 x 160.3 4.31 x 6.31	 









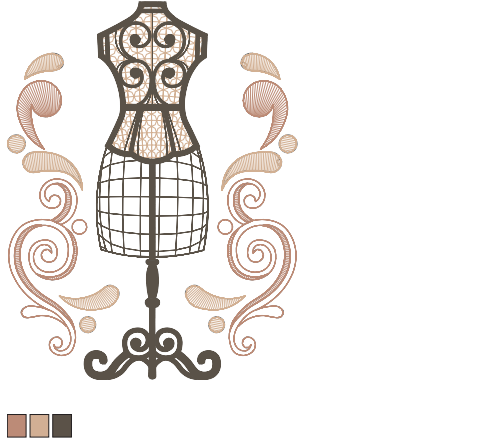
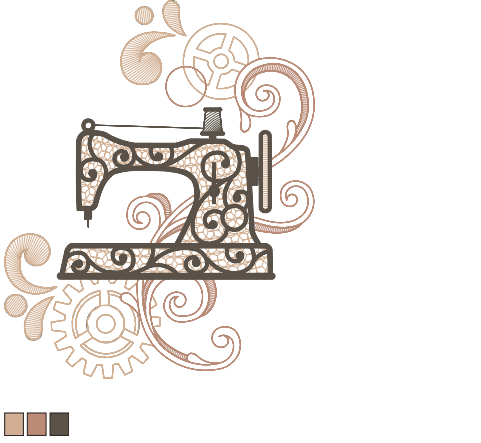
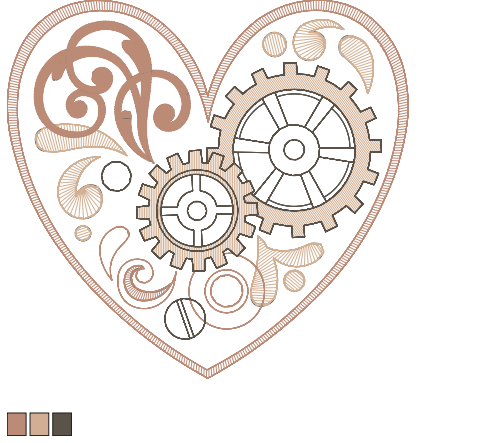



No.	Embroidery motif	No.	Embroidery motif
Width x Height	Colors	Width x Height	Colors
> mm		> mm	
> inch		> inch	
BD563		BD569_48	
			
89.7 x 89.6		120.6 x 120.6	
3.53 x 3.52		4.74 x 4.74	

### Ornaments



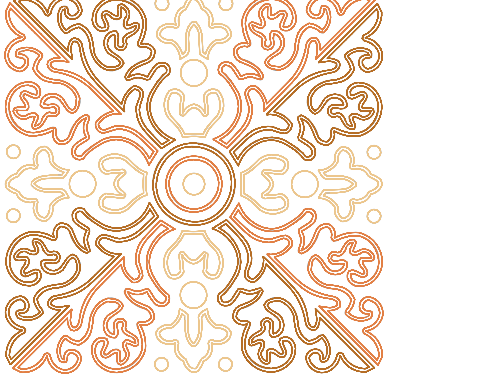

No.	Embroidery motif	No.	Embroidery motif
Width x Height	Colors	Width x Height	Colors
> in mm		> in mm	
> in inch		> in inch	
NB843-48		NB826-48	
87.6 x 121.1		134.9 x 132.9	
3.44 x 4.76		5.31 x 5.23	

No. Width x Height > in mm > in inch	Embroidery motif Colors	No. Width x Height > in mm > in inch	Embroidery motif Colors
12633-06 119.8 x 119.9 4.71 x 4.72	 	12473-04 93.6 x 184.2 3.68 x 7.25	 
BE7904-03 140.0 x 130.4 5.51 x 5.13	 	12473-06 133.4 x 119.9 5.25 x 4.72	 
80090-06  83.6 x 37.0 3.29 x 1.45	 	80090-07  128.1 x 36.5 5.04 x 1.43	 

No. Width x Height > in mm > in inch	Embroidery motif Colors	No. Width x Height > in mm > in inch	Embroidery motif Colors
19999-002 124.9 x 136.4 4.91 x 5.37		NB934-48 132.4 x 164.8 5.21 x 6.48	
NB935-48 104.1 x 168.9 4.09 x 6.64		21021-05 118.7 x 155.7 4.67 x 6.12	
21021-04 123.1 x 150.2 4.84 x 5.91		21021-06 116.0 x 109.5 4.56 x 4.31	





No. Width x Height > in mm > in inch	Embroidery motif Colors	No. Width x Height > in mm > in inch	Embroidery motif Colors
12490-03  118.1 x 113.4  4.64 x 4.46	 	12490-04  146.4 x 122.4  5.76 x 4.81	 
12490-05  125.8 x 104.5  4.95 x 4.11	 	FP887  186.7 x 134.8  7.35 x 5.30	 
12528-12  123.8 x 123.8  4.87 x 4.87	 	12528-03  76.6 x 130.5  3.01 x 5.13	 





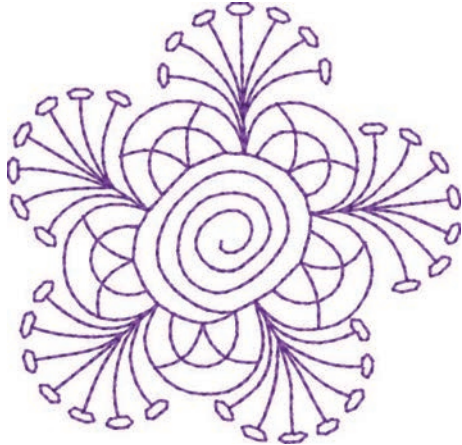

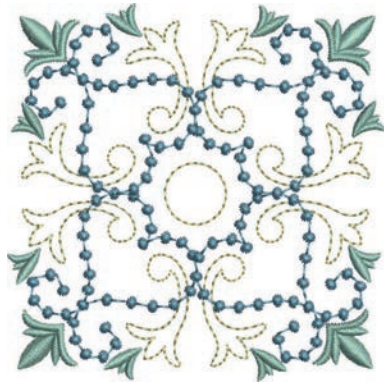





Overview stitch patterns

No. Width x Height > in mm > in inch	Embroidery motif Colors	No. Width x Height > in mm > in inch	Embroidery motif Colors
OC07207  105.8 x 138.6  4.16 x 5.45	 	82007-11    111.7 x 94.2  4.39 x 3.70	 
82007-44  114.0 x 114.8  4.48 x 4.51	 	82006-30    99.9 x 174.6  3.93 x 6.87	 
NB251  71.6 x 103.3  2.81 x 4.06	 	BE790405  125.9 x 185.4  4.95 x 7.29	 



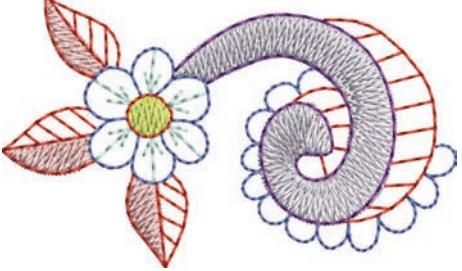









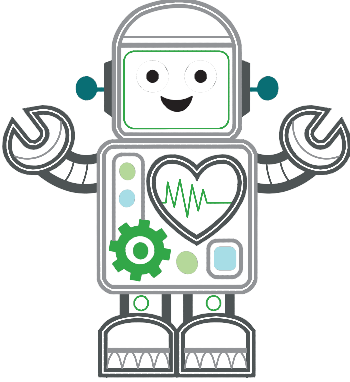









No. Width x Height > in mm > in inch	Embroidery motif Colors	No. Width x Height > in mm > in inch	Embroidery motif Colors
FB126 86.9 x 102.2 3.42 x 4.02		BE790502 59.9 x 58.2 2.35 x 2.29	
21003-26  123.0 x 124.1 4.84 x 4.88		NB403 78.1 x 78.3 3.07 x 3.08	
NB373 121.4 x 176.8 4.77 x 6.96		NB442 55.6 x 58.4 2.18 x 2.29	



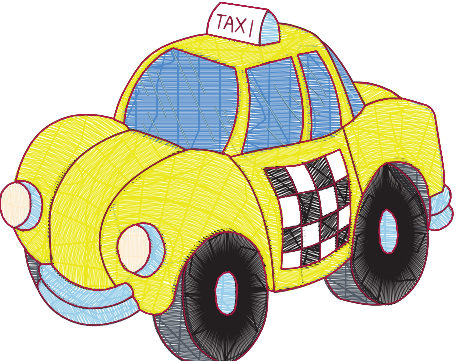

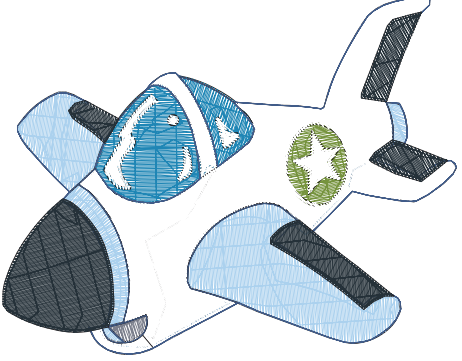

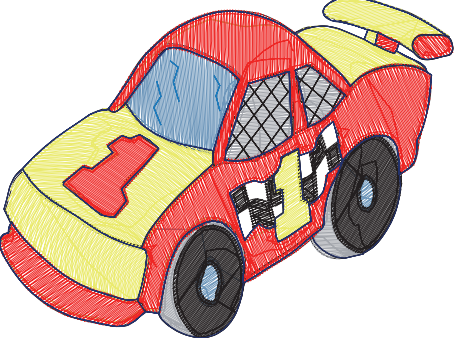

No. Width x Height > in mm > in inch	Embroidery motif Colors	No. Width x Height > in mm > in inch	Embroidery motif Colors
NB481 123.4 x 67.6 4.85 x 2.66	 	NB749 126.5 x 262.8 4.98 x 10.34	 
NA959  75.6 x 103.7 2.97 x 4.08	 	FB106 128.1 x 92.6 5.04 x 3.64	 
NB002 59.3 x 35.1 2.33 x 1.38	 	FQ870 122.1 x 105.1 4.80 x 4.13	 





No.	Embroidery motif	No.	Embroidery motif
Width x Height > in mm > in inch	Colors	Width x Height > in mm > in inch	Colors
WS655 116.5 x 222.3 4.58 x 8.75			







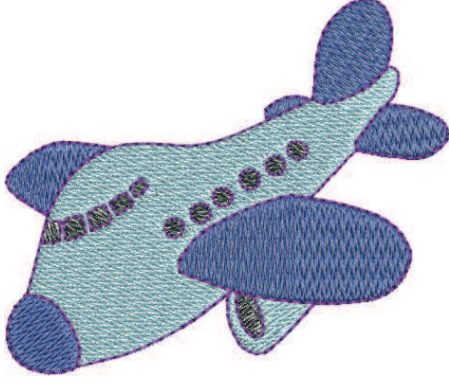



### Children









No.	Embroidery motif	No.	Embroidery motif
Width x Height > mm > inch	Colors	Width x Height > mm > inch	Colors
12590-03  135.5 x 146.9 5.33 x 5.78	 	CK867  122.2 x 132.8 4.81 x 5.22	 

No. Width x Height > mm > inch	Embroidery motif Colors	No. Width x Height > mm > inch	Embroidery motif Colors
CM031-48 85.7 x 63.4 3.37 x 2.49	 	12401-17 98.8 x 55.1 3.88 x 2.16	 
CK859  118.8 x 141.8 4.67 x 5.58	 Tickle My Tummy 	CK520 75.6 x 60.3 2.97 x 2.37	 
CK510 76.2 x 59.9 3.00 x 2.35	 	CK522 70.8 x 53.1 2.78 x 2.09	 

No. Width x Height > mm > inch	Embroidery motif Colors	No. Width x Height > mm > inch	Embroidery motif Colors
CK863  127.1 x 124.6 5.00 x 4.90	 <p>Wish Upon My Star Light</p> 	NB198-48 94.2 x 72.4 3.70 x 2.85	 
BE790307  141.5 x 126.9 5.57 x 4.99	 	BE790311  114.1 x 152.5 4.49 x 6.00	 
BE790305  118.3 x 145.5 4.65 x 5.72	 	BE790306  132.1 x 151.4 5.20 x 5.96	 











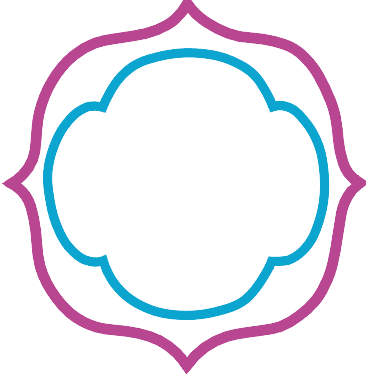

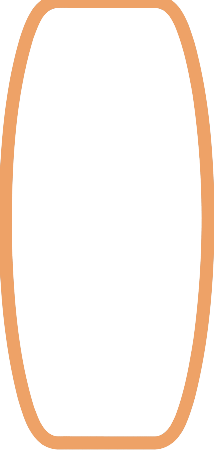
No. Width x Height > mm > inch	Embroidery motif Colors	No. Width x Height > mm > inch	Embroidery motif Colors
BE790309  87.5 x 149.8 3.44 x 5.89	 	BE790310  137.8 x 136.0 5.42 x 5.35	 
BE790312  122.0 x 133.1 4.80 x 5.24	 	BE790313  98.9 x 102.3 3.89 x 4.02	 
CK511 76.2 x 64.6 3.00 x 2.54	 	CM193-48  106.7 x 127.4 4.20 x 5.01	 

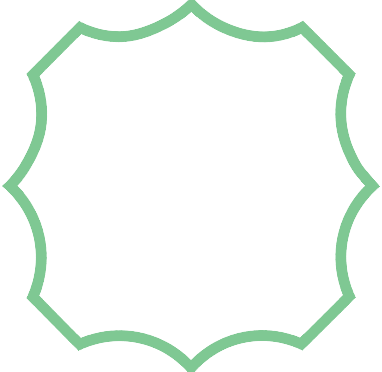
No. Width x Height > mm > inch	Embroidery motif Colors	No. Width x Height > mm > inch	Embroidery motif Colors
CK667  99.8 x 82.3 3.92 x 3.24	 	CK738 89.1 x 85.7 3.50 x 3.37	 
CK970 84.4 x 81.6 3.33 x 3.21	 	CM147 55.0 x 99.6 2.16 x 3.92	 
CM22648 63 x 63 2.5 x 2.5	 	CM348 119.0 x 167.1 4.68 x 6.57	 

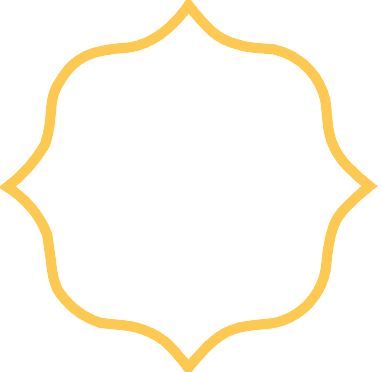

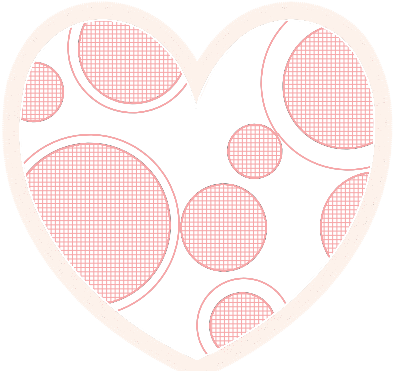







No. Width x Height > mm > inch	Embroidery motif Colors	No. Width x Height > mm > inch	Embroidery motif Colors
CM362  120.6 x 113.0 4.74 x 4.44	 	CM376  100.3 x 97.5 3.94 x 3.84	 
NB193 113.3 x 96.2 4.46 x 3.78	 		





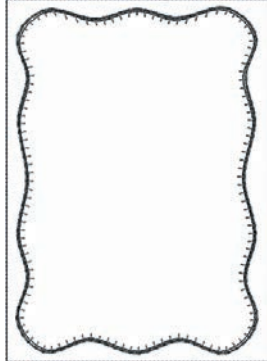

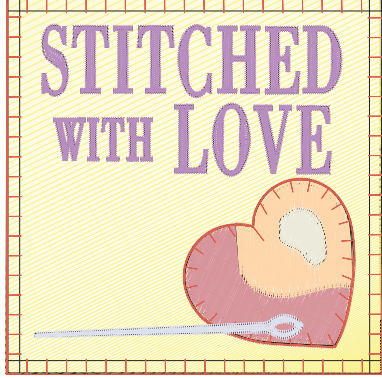





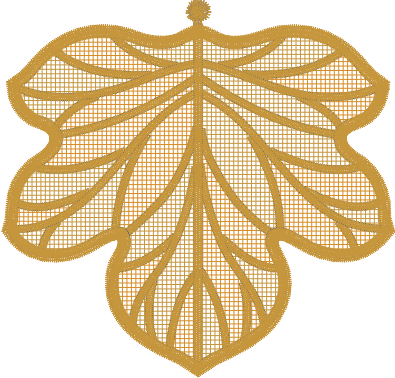

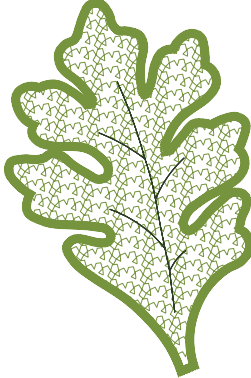

### Frames and borders



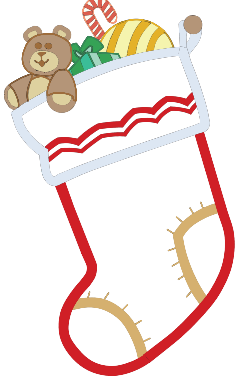
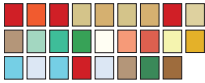







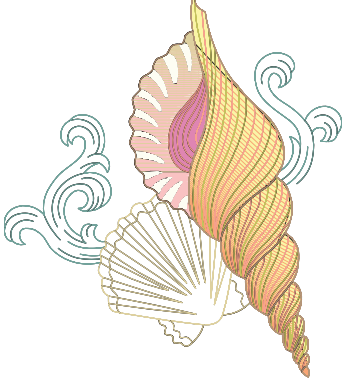

No. Width x Height > mm > inch	Embroidery motif Colors	No. Width x Height > mm > inch	Embroidery motif Colors
80090-26  124.4 x 128.8 4.89 x 5.07	 	12630-07  97.0 x 205.0 3.8 x 8.1	 
12611-27  136.9 x 137.3 5.38 x 5.40	 	12611-28  140.0 x 140.0 5.51 x 5.51	 
12649-05  91.2 x 88.6 3.59 x 3.48	 	12606-26  138.8 x 138.8 5.46 x 5.46	 

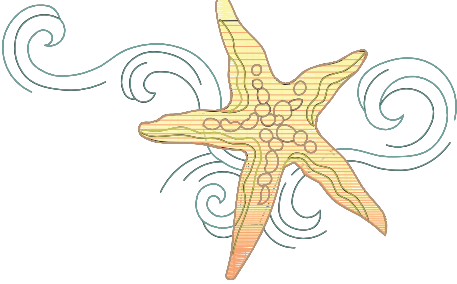









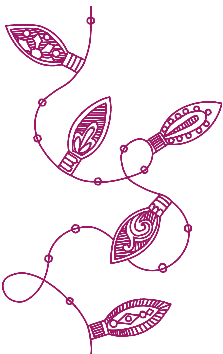

Overview stitch patterns











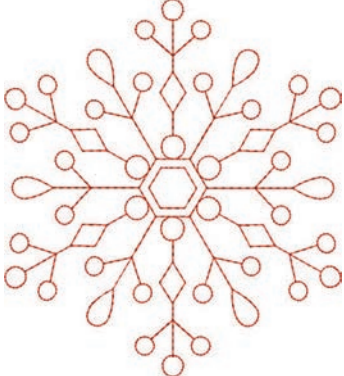

No. Width x Height > mm > inch	Embroidery motif Colors	No. Width x Height > mm > inch	Embroidery motif Colors
12606-33  43.0 x 70.0 1.69 x 2.75	 	12606-37  45.6 x 77.8 1.79 x 3.06	 
32078-02  123.4 x 172.9 4.85 x 6.80	 	32078-03  123.4 x 172.9 4.85 x 6.80	 
32078-04  123.4 x 172.9 4.85 x 6.80	 	NZ195 76.8 x 76.8 3.02 x 3.02	 



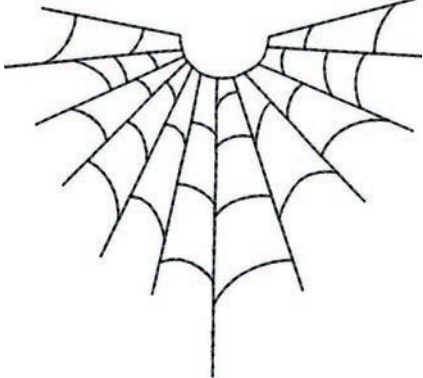











No. Width x Height > mm > inch	Embroidery motif Colors	No. Width x Height > mm > inch	Embroidery motif Colors
12597-16  88.4 x 85.0  3.48 x 3.34	 	80009-17  85.7 x 129.8  3.37 x 5.11	 
HE255   133.2 x 127.1  5.24 x 5.00	 	HE252   88.1 x 145.0  3.46 x 5.70	 
HG746-48   111.6 x 138.2  4.39 x 5.44	 	RC514  74.3 x 98.8  2.92 x 3.88	 

No. Width x Height > mm > inch	Embroidery motif Colors	No. Width x Height > mm > inch	Embroidery motif Colors
HG747-48  124.0 x 147.5 4.88 x 5.80	 	NB754-48 114.3 x 128.1 4.50 x 5.04	 
NB759-48 98.7 x 61.7 3.88 x 2.42	 	HD976 101.1 x 108.3 3.98 x 4.26	 
HG806-48 27.7 x 170.4 1.07 x 6.70	 	12415-32 79.6 x 191.2 3.13 x 7.52	 

No. Width x Height > mm > inch	Embroidery motif Colors	No. Width x Height > mm > inch	Embroidery motif Colors
12415-29 108.4 x 172.4 4.26 x 6.78	 	12655-14 164 x 110 6.45 x 4.33	 
12433-05  83.4 x 124.4 3.28 x 4.89	 	12417-04 84.3 x 97.1 3.31 x 3.82	 
BE790303 69.5 x 70.1 2.73 x 2.75	 	BE790301 127.2 x 89.0 5.00 x 3.50	 



No. Width x Height > mm > inch	Embroidery motif Colors	No. Width x Height > mm > inch	Embroidery motif Colors
GNNF80834  95.2 x 78.8  3.74 x 3.10	 	HE962  120.5 x 135.2  4.74 x 5.32	 
12421-11  39.9 x 43.6  1.57 x 1.71	 	12421-37  67.4 x 61.0  2.65 x 2.40	 
12421-03  45.8 x 48.3  1.80 x 1.90	 	CM287  90.4 x 117.2  3.55 x 4.61	 

No. Width x Height > mm > inch	Embroidery motif Colors	No. Width x Height > mm > inch	Embroidery motif Colors
CM426 45.8 x 96.0 1.80 x 3.77	 	FQ749 77.6 x 94.8 3.05 x 3.73	 
HE919 89.1 x 69.2 3.50 x 2.72	 	HG053 122.1 x 121.8 4.80 x 4.79	 
HG319 88.6 x 151.5 3.48 x 5.96	 	HG460 91.8 x 98.1 3.61 x 3.86	 





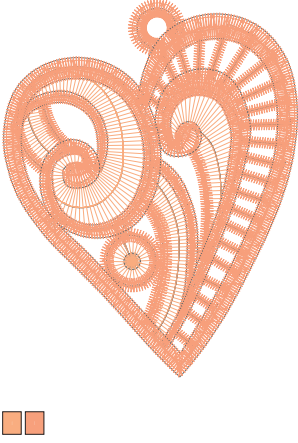





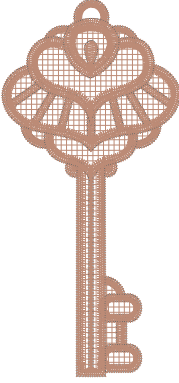

















No.	Embroidery motif	No.	Embroidery motif
Width x Height	Colors	Width x Height	Colors
> mm		> mm	
> inch		> inch	
NB317 87.4 x 86.9 3.44 x 3.42			

### Borders and Lace













No.	Embroidery motif	No.	Embroidery motif
Width x Height	Colors	Width x Height	Colors
> mm		> mm	
> inch		> inch	
12659-01  45.2 x 57.8 1.77 x 2.27		12659-06  36.7 x 59.5 1.44 x 2.34	











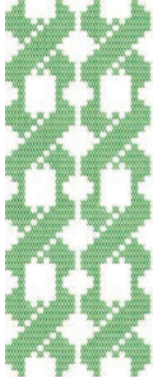

Overview stitch patterns



No. Width x Height > mm > inch	Embroidery motif Colors	No. Width x Height > mm > inch	Embroidery motif Colors
21021-25  33.8 x 71.5 1.33 x 2.81	 	OC00303  100.6 x 110.6 3.96 x 4.35	 
HG341 63.8 x 63.7 2.51 x 2.50	 	NX957 97.9 x 88.1 3.85 x 3.46	 
NX696 91.2 x 90.7 3.59 x 3.57	 	FB461  121.7 x 121.6 4.79 x 4.78	 

No. Width x Height > mm > inch	Embroidery motif Colors	No. Width x Height > mm > inch	Embroidery motif Colors
12633-20 34.3 x 170.1 1.35 x 6.69	 	12508-08 40.0 x 150.9 1.57 x 5.94	 
12508-17 42.1 x 152.5 1.65 x 6.00	 	OC33411 24.2 x 177.1 0.95 x 6.97	 
OC33416  36.4 x 127.8 1.43 x 5.03	 	12485-12 41.3 x 139.0 1.62 x 5.47	 







Overview stitch patterns



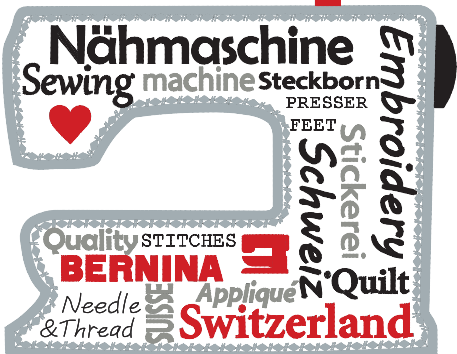







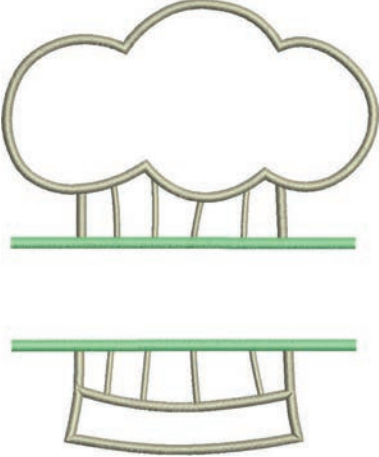

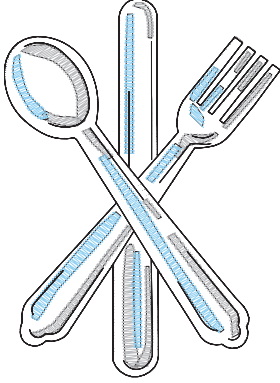
No. Width x Height > mm > inch	Embroidery motif Colors	No. Width x Height > mm > inch	Embroidery motif Colors
12485-31 45.6 x 225.2 1.79 x 8.86	 	21013-29 40.2 x 152.0 1.58 x 5.98	 
BE110415 43.7 x 172.4 1.72 x 6.78	 	FA981 35.1 x 142.3 1.38 x 5.60	 
21002-21 21.6 x 150.9 0.85 x 5.94	 	21009-29 31.9 x 152.6 1.25 x 6.00	 

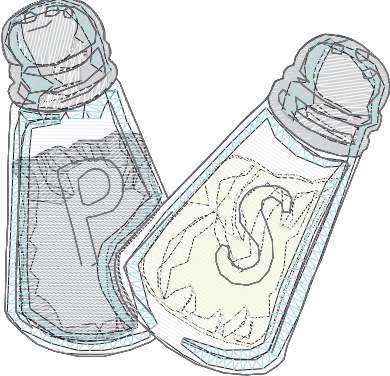
No. Width x Height > mm > inch	Embroidery motif Colors	No. Width x Height > mm > inch	Embroidery motif Colors
82005-40 26.0 x 239.4 1.02 x 9.42	 	BE790702 73.0 x 190.5 2.87 x 7.50	 
NA914 18.8 x 120.3 4.73 x 0.74	 	NB520 26.3 x 175.9 1.03 x 6.92	 
HG177 50.0 x 158.6 1.96 x 6.24	 	CM473 31.8 x 209.6 1.25 x 8.25	 

No.	Embroidery motif	No.	Embroidery motif
Width x Height	Colors	Width x Height	Colors
> mm		> mm	
> inch		> inch	
FB436			
29.2 x 132.8			
1.15 x 5.22			
			









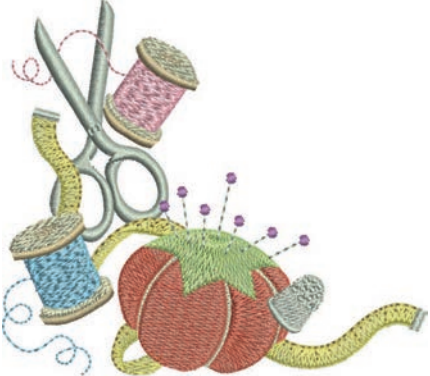

### Sports and hobby

No.	Embroidery motif	No.	Embroidery motif
Width x Height	Colors	Width x Height	Colors
> mm		> mm	
> inch		> inch	
82014-28		12611-08	
			
141.5 x 117.1		80.0 x 119.7	
5.57 x 4.61		3.14 x 4.71	
			



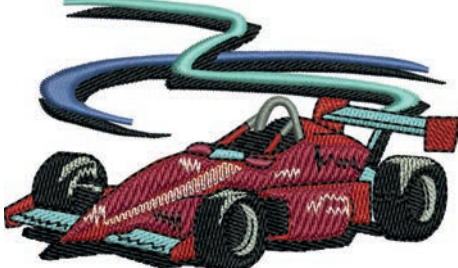











No. Width x Height > mm > inch	Embroidery motif Colors	No. Width x Height > mm > inch	Embroidery motif Colors
12611-18  130.2 x 157.6 5.12 x 6.20	 	NX737 72.1 x 98.7 2.83 x 3.88	 
NX741 80.0 x 78.0 3.14 x 3.07	 	12383-18 90.7 x 171.2 3.57 x 6.74	 
12472-01  137.7 x 141.7 5.42 x 5.57	 	SP980 63.2 x 63.5 2.48 x 2.50	 





No. Width x Height > mm > inch	Embroidery motif Colors	No. Width x Height > mm > inch	Embroidery motif Colors
BE790606 100.2 x 86.0 3.94 x 3.38		BE790608 80.3 x 80.1 3.16 x 3.15	
BE790603 80.5 x 74.8 3.16 x 2.94		BE790602 80.3 x 75.6 3.16 x 2.97	
SP989 101.6 x 82.5 4.00 x 3.24		SR067 87.5 x 96.6 3.44 x 3.81	







No. Width x Height > mm > inch	Embroidery motif Colors	No. Width x Height > mm > inch	Embroidery motif Colors
FB148 101.1 x 89.5 3.98 x 3.52	 	SR589 95.2 x 66.5 3.75 x 2.61	 
LT870 97.5 x 57.0 3.83 x 2.24	 	RC244 88.4 x 53.4 3.48 x 2.10	 
SR551 120.3 x 38.0 4.73 x 1.49	 		







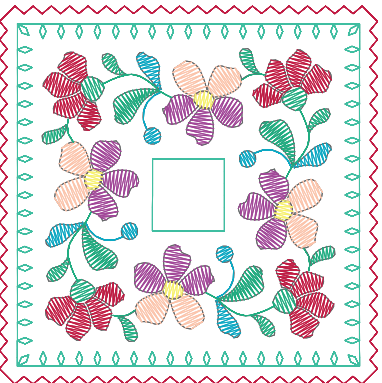





## Animals











No. Width x Height > mm > inch	Embroidery motif Colors	No. Width x Height > mm > inch	Embroidery motif Colors
WP415-48  132.4 x 148.4  5.21 x 5.84	 	CM216-48   47.0 x 67.0  1.85 x 2.63	 
CM213-48   58.3 x 101.9  2.29 x 4.01	 	WP421-48  95.8 x 137.5  3.77 x 5.41	 
NA248  77.5 x 73.3  3.05 x 2.88	 	HD977  97.7 x 98.6  3.84 x 3.88	 

No.	Embroidery motif	No.	Embroidery motif
Width x Height	Colors	Width x Height	Colors
> mm		> mm	
> inch		> inch	
LJ598 106.5 x 81.5 4.19 x 3.20	 	CM220  71.5 x 71.8 2.81 x 2.82	 

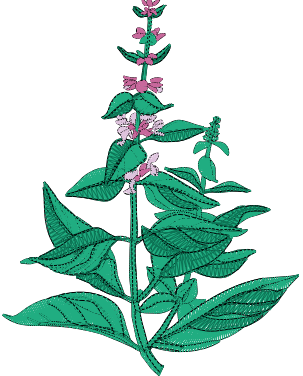











### Flowers







No.	Embroidery motif	No.	Embroidery motif
Width x Height	Colors	Width x Height	Colors
> mm		> mm	
> inch		> inch	
21027-01 123.0 x 122.2 4.84 x 4.81	 	21027-14 120.8 x 120.8 4.75 x 4.75	 

No. Width x Height > mm > inch	Embroidery motif Colors	No. Width x Height > mm > inch	Embroidery motif Colors
21027-16  57.4 x 151.8  2.25 x 5.97	 	21027-17  57.3 x 151.4  2.25 x 5.96	 
21017-01  104.5 x 157.5  4.11 x 6.20	 	FI135  88.5 x 87.1  3.48 x 3.42	 
FI136  84.7 x 89.2  3.33 x 3.51	 	FI138  85.0 x 75.5  3.34 x 2.97	 

No. Width x Height > mm > inch	Embroidery motif Colors	No. Width x Height > mm > inch	Embroidery motif Colors
FI142 79.0 x 85.8 3.11 x 3.37	 	FI230 78.1 x 72.4 3.07 x 2.85	 
FI171 69.5 x 88.9 2.73 x 3.50	 	82006-07 123.7 x 165.6 4.87 x 6.51	 
21006-02 114.5 x 135.5 4.50 x 5.33	 	80001-23 85.0 x 101.6 3.34 x 4.00	 







Overview stitch patterns

No. Width x Height > mm > inch	Embroidery motif Colors	No. Width x Height > mm > inch	Embroidery motif Colors
12457-06 106.3 x 172.3 4.18 x 6.78	 	12457-13 113.1 x 130.3 4.45 x 5.12	 
21009-21 64.9 x 107.7 2.55 x 4.24	 	BE790408 58.3 x 89.7 2.29 x 3.53	 
21002-02 109.7 x 160.0 4.31 x 6.29	 	21012-04 123.1 x 123.9 4.84 x 4.87 	 

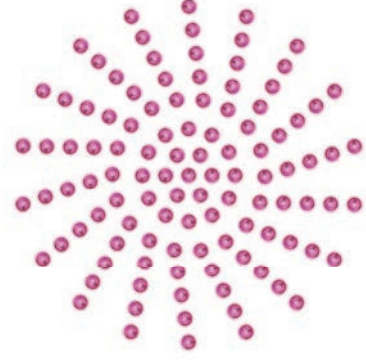













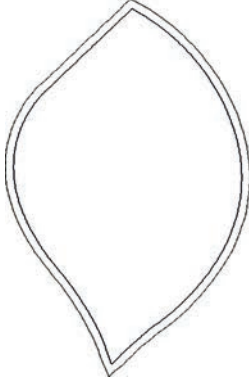

No. Width x Height > mm > inch	Embroidery motif Colors	No. Width x Height > mm > inch	Embroidery motif Colors
FB492  86.8 x 293.2  3.41 x 11.54		FP246  65.6 x 61.8  2.58 x 2.43	
FP814  88.0 x 84.4  3.46 x 3.32		FQ562  90.3 x 156.3  3.55 x 6.15	
FQ722  80.0 x 90.6  3.14 x 3.56		FQ733  66.5 x 66.5  2.61 x 2.61	

No.	Embroidery motif	No.	Embroidery motif
Width x Height	Colors	Width x Height	Colors
> mm		> mm	
> inch		> inch	
FQ801		NB209	
46.0 x 112.5		90.0 x 89.9	
1.81 x 4.42		3.54 x 3.53	





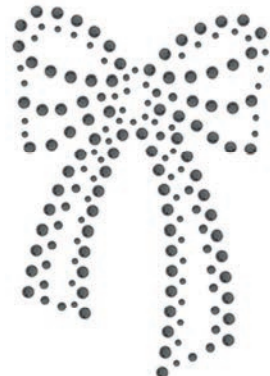







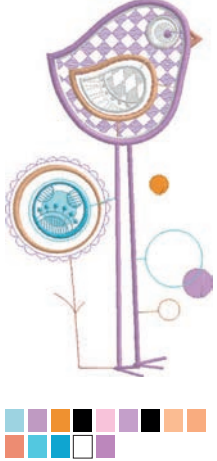

### Designs with special effects

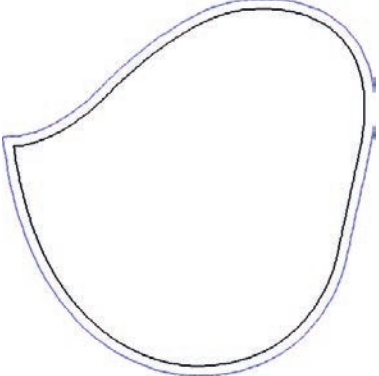

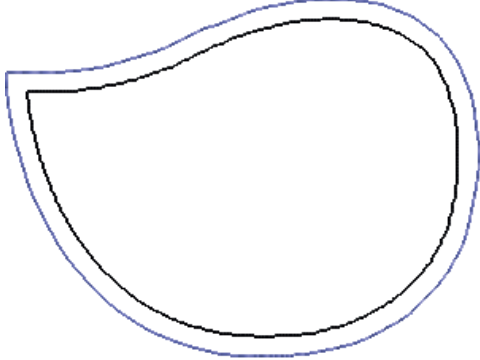

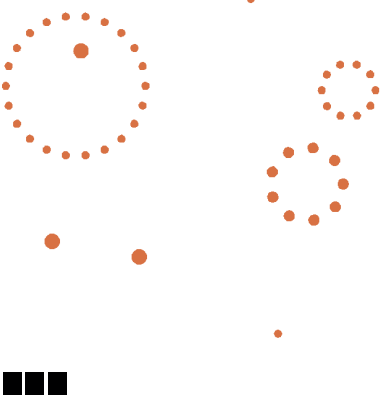

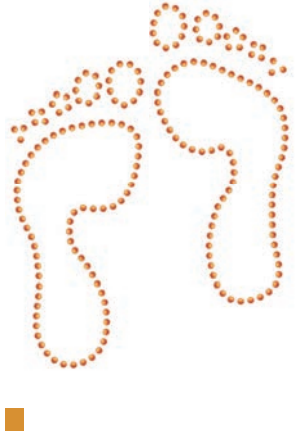

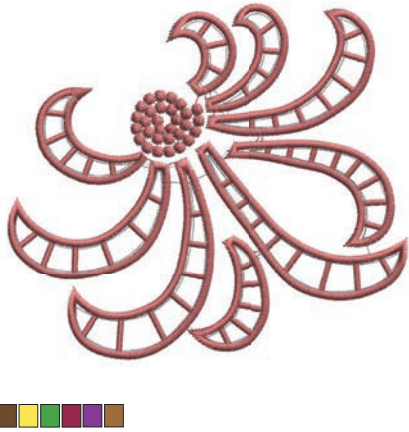

No.	Embroidery motif	No.	Embroidery motif
Width x Height	Colors	Width x Height	Colors
> mm		> mm	
> inch		> inch	
DW11		21026-08_DW	
			
70 x 71		86.4 x 174.0	
2.76 x 2.80		3.40 x 6.85	



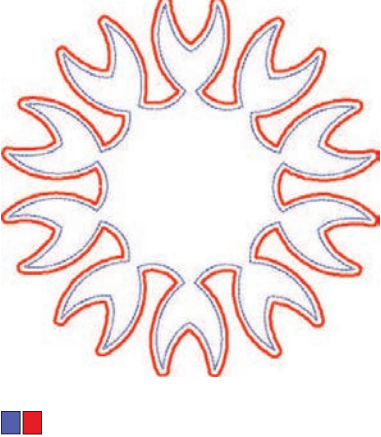

No. Width x Height > mm > inch	Embroidery motif Colors	No. Width x Height > mm > inch	Embroidery motif Colors
21026-02_DW  68.6 x 193.8 2.70 x 7.62	 	21026_-02  60.8 x 93.8 2.39 x 3.69	
21026-02_CR  103 x 127 4.05 x 0.47	 	12448-09_PW  121 x 161 4.76 x 6.34	 
21026-05_DW  118.0 x 201.9 4.64 x 7.94	 	12448-11_CR  84 x 123 3.31 x 4.84	 

Overview stitch patterns

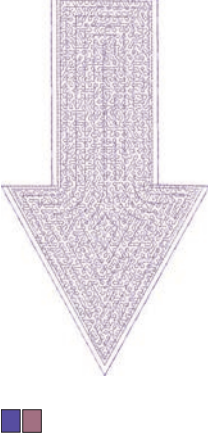
No. Width x Height > mm > inch	Embroidery motif Colors	No. Width x Height > mm > inch	Embroidery motif Colors
12448-08_PW  119.1 x 177.4 4.68 x 6.98	 	21022-13_DW   105.6 x 192.8 4.15 x 7.59	
21022_-13  75.4 x 76.4 2.96 x 3.00		21022-13_CWA_B  47.7 x 36.2 1.86 x 1.42	
21022-13_CR  95 x 86 3.74 x 3.39	 	DW07  114 x 152 4.49 x 5.98	 

No. Width x Height > mm > inch	Embroidery motif Colors	No. Width x Height > mm > inch	Embroidery motif Colors
DW05  105 x 94 4.13 x 3.70		DW10  119 x 119 4.69 x 4.69	
DW08  100 x 206 3.94 x 8.11		BE700121  128 x 128 5.0 x 5.1	
BE700122  119.4 x 37.0 4.70 x 1.45		BE700123  112.7 x 205.8 4.43 x 8.10	

No. Width x Height > mm > inch	Embroidery motif Colors	No. Width x Height > mm > inch	Embroidery motif Colors
BE700124  141.0 x 134.4 5.55 x 5.29	 		



Upper thread tension .....	50
Using eco mode.....	65
Using the spool net.....	32

**V**

Virtual positioning of the embroidery hoop .....	49
--	----





in partnership with

*Mettler*

BERNINA International AG | CH-8266 Steckborn Switzerland | [www.bernina.com](http://www.bernina.com) | © Copyright by BERNINA International AG

1028895\_10A.04  
2019-09 EN

made to create **BERNINA**